



# Mi Electric Scooter User Manual

# Thank you for purchasing

Thank you for purchasing Mi Electric Scooter. It is a sports and recreational vehicle with style.

## Contents

1. Package Contents .....	02
2. Product Overview .....	03
3. Assembly and Set-Up .....	04
4. Charge Your Scooter .....	05
5. How To Ride .....	05
6. Safety Instructions .....	07
7. Folding and Carrying .....	13
8. Daily Care and Maintenance.....	14
9. Specifications.....	17
10. Trademark and Legal statement.....	18
11. Certifications .....	19
12. Connect with Mi Home / Xiaomi Home App.....	22

# 1. Package Contents

## Assembled Electric Scooter

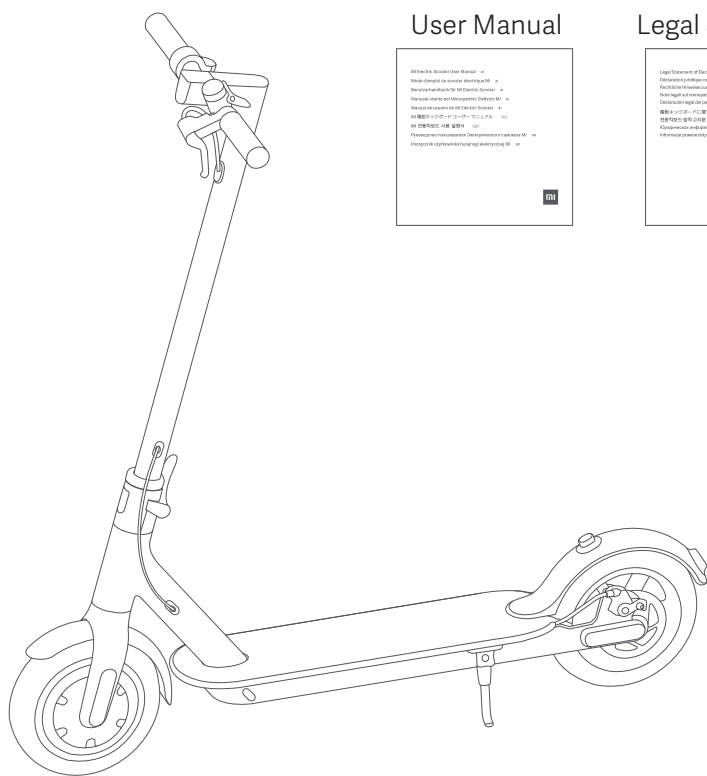

### User Manual

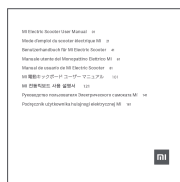

### Legal Statement

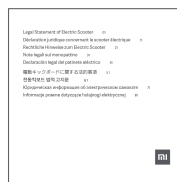

### Quick Start Guide



## Accessories

Extended Nozzle Adapter



Screw × 4



Hexagon Wrench



tire × 2



Charging Adapter

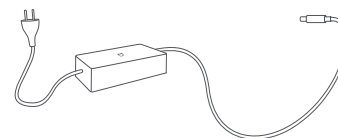

Carefully check package contents, if anything is missing or damaged, please contact local customer service for support.

## 2. Product Overview

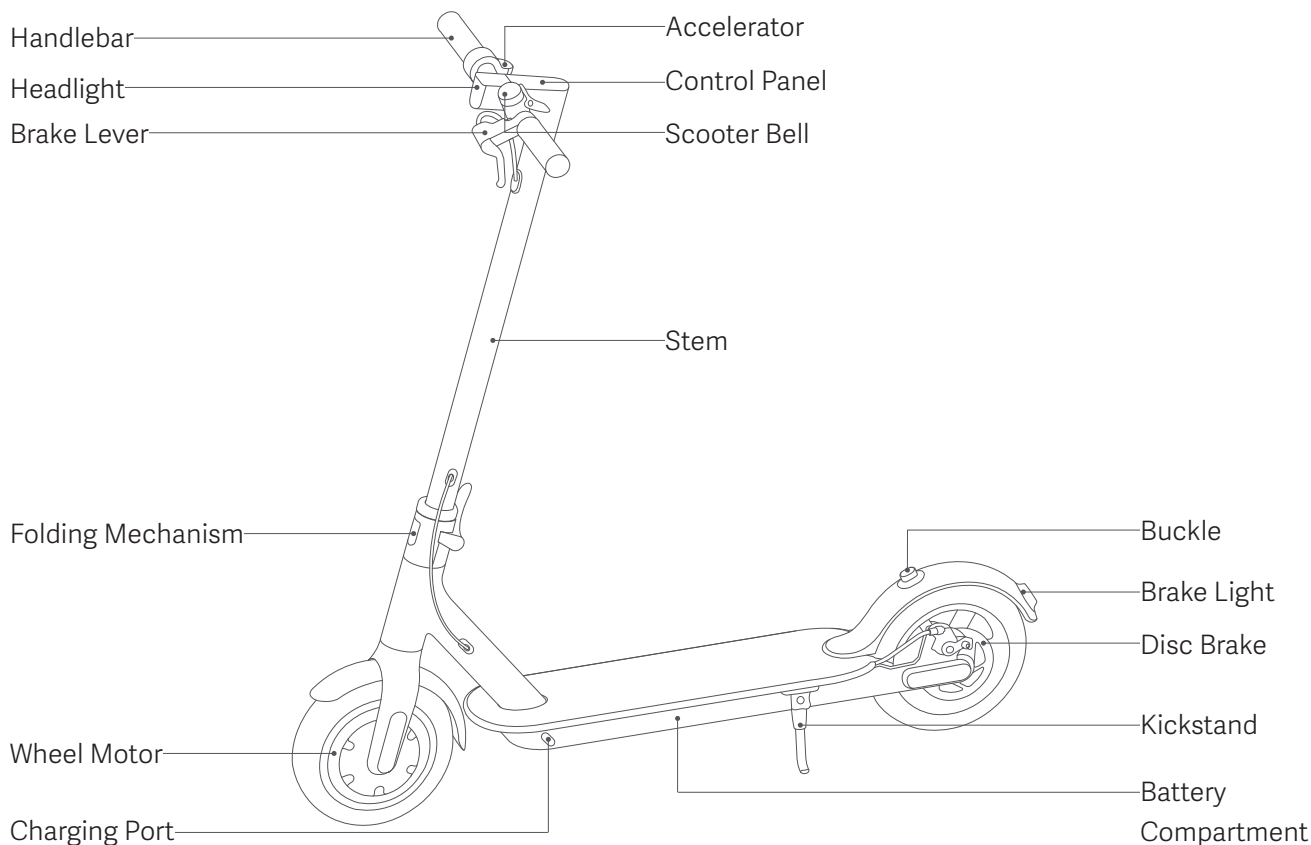

### Control Panel

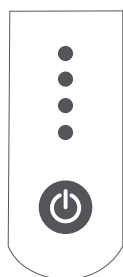

Battery level display

The power level is indicated by four power lights on the control panel. As power is consumed, the lights will change from solid to flashing, and finally turn off from up to down. When all four power lights are on, the battery level is between 100% - 86%; When three lights are solid and one is flashing, the battery level is between 85% - 71%, and so on. When the bottom power light flashes, it indicates low power. Please recharge soon for further use. After running out of power, all lights will turn off, and the scooter will coast until it comes to a complete stop.

Mode display

The bottom light either flashes white or green. The white light indicates regular mode, and green light indicates power-saving mode. (power-saving mode: max speed of 18km/h with smoother acceleration for beginners)

Power button

When the scooter is off, press the button to turn on the scooter; When the scooter is on, press and hold for 2 seconds to turn off the scooter. After turning on, press the button to turn on or off the headlight; And press twice to switch between modes.

### 3. Assembly and Set-Up

1. Fasten the handlebar stem on the headset, and put the kickstand down

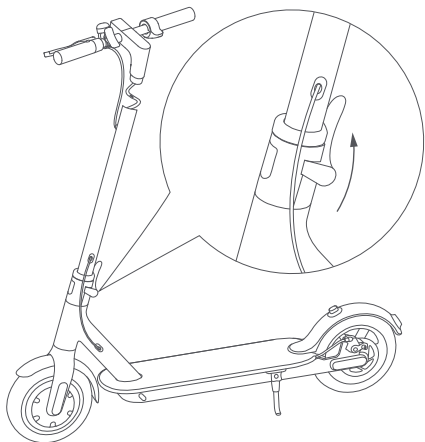

2. Attach the handlebar to the stem

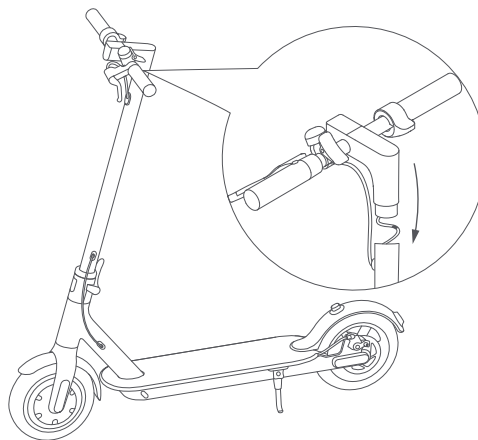

3. Tighten the screws onto both sides of the stem with the hexagon wrench

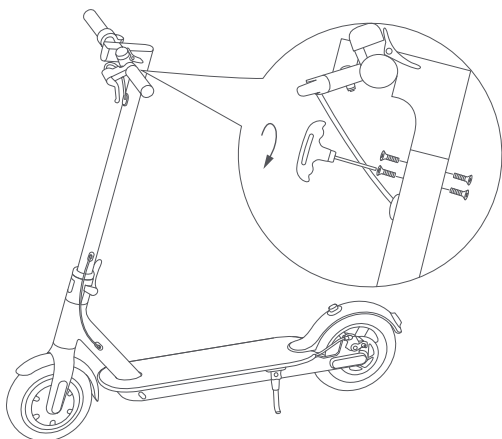

4. After the assembly, press the power button to check if it's working properly

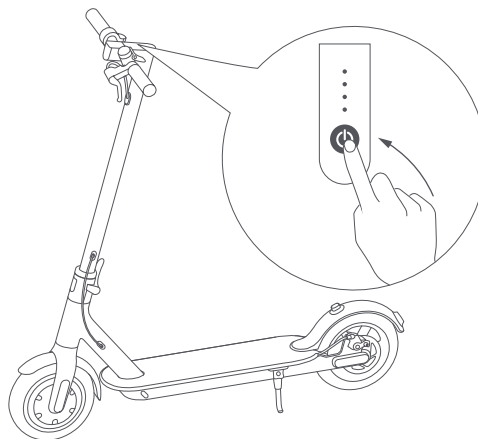

## 4. Charge Your Scooter

Charging condition description:

The scooter is fully charged when the LED on the charger changes from red (charging) to green (trickle charge).

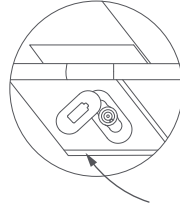
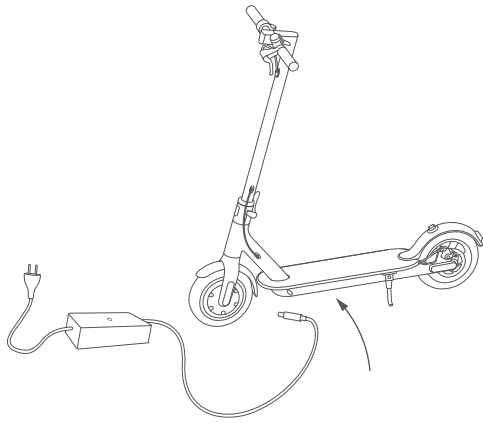

Lift up the rubber flap

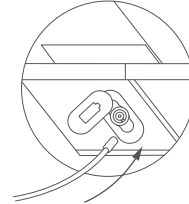

Plug the power adapter into the charging port

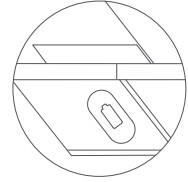

When charging is completed, put back the rubber flap

---

## 5. How To Ride

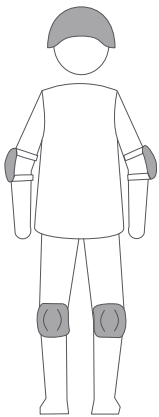

Warning: Wear a helmet, elbow pads and knee pads. Please read the instruction carefully before using. Do not touch the brake system. Refer to the instruction for more information

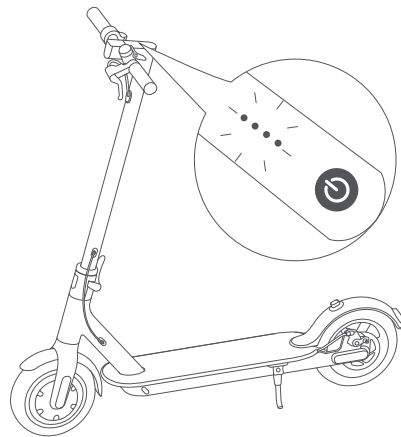

1. Turn on the scooter, and check the power indicator

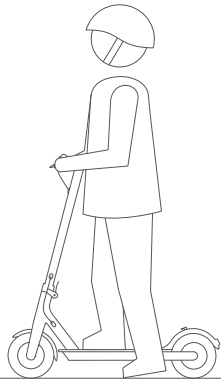

2. Step on the deck with one foot, and slowly kicks off the other on the ground. When the scooter starts to coast, put both feet on the deck and press the accelerator (the accelerator initiates once the coasting speed exceeds 5km/h)

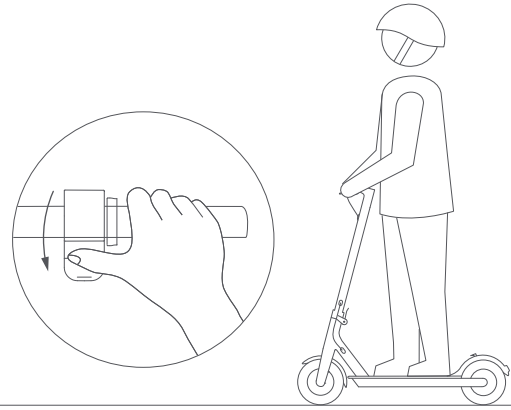

3. When the scooter is at a full stop, the accelerator automatically turns off. To restart the scooter, it is necessary to repeat step 2

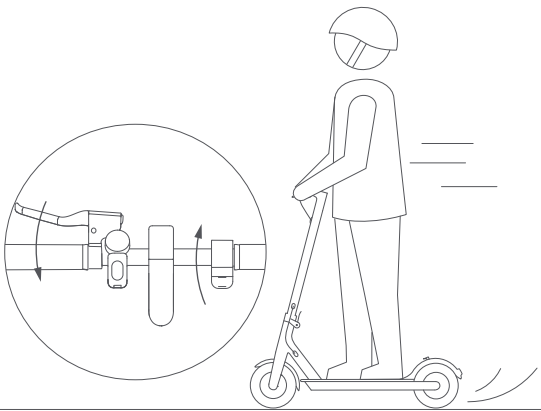

4. Release the accelerator and the kinetic energy recovery system (KERS) initiates automatically to brake slowly; And squeeze the brake lever for a sudden brake

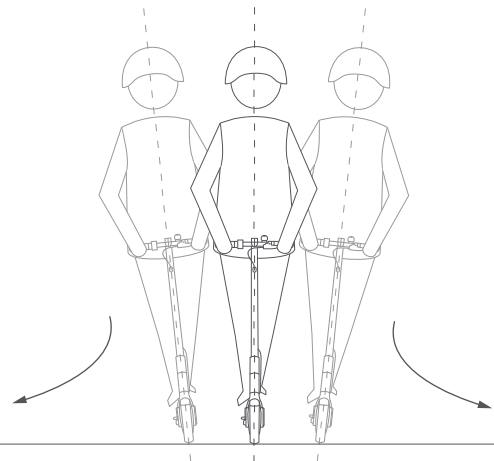

5. Tilt your body to the steering direction as you turn, and slowly turn the handlebar

## 6. Safety Instructions

## Watch out for safety risks



 Do not ride in the rain



 Do not accelerate when you go downhill

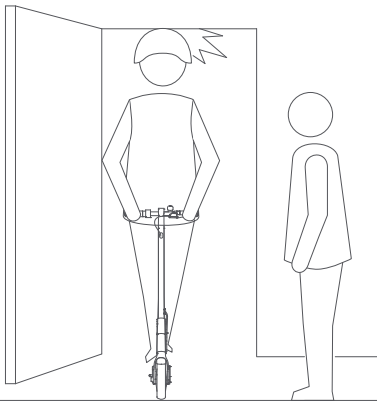

 Look out for doors, elevators and other overhead obstacles

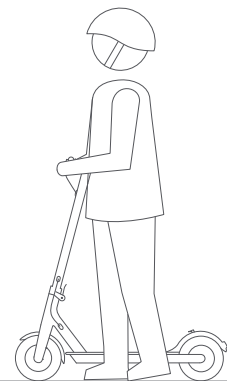
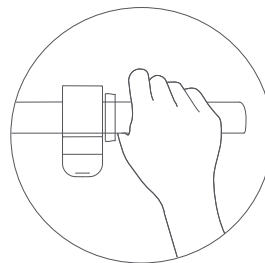



 Do not press the accelerator when you're walking alongside the scooter



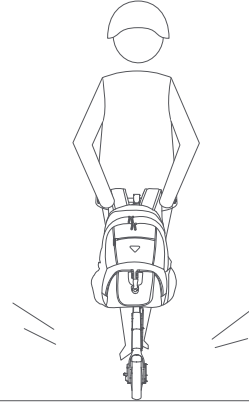
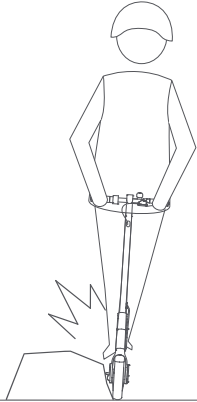

 To prevent inappropriate use of the scooter, the rear wheel of the machine must be locked with a padlock when parked.

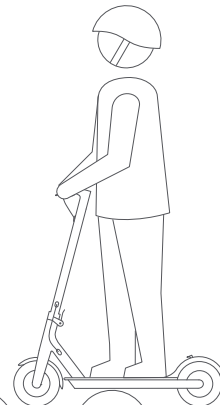
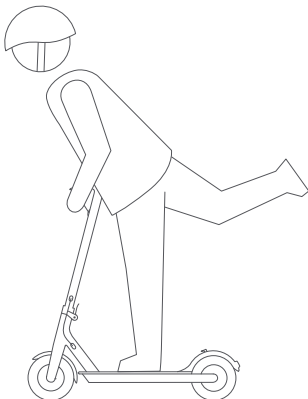

 Always steer clear of obstacles

 Do not hang bags or other heavy stuff on the handlebar



 Keep both feet on the deck all time.

 Keep your speed between 5–10 km/h when you ride through speed bumps, elevator door stills, bumpy roads or other uneven surfaces. Slightly bend your knee to better adjust mentioned surfaces.

## Do not try following dangerous actions

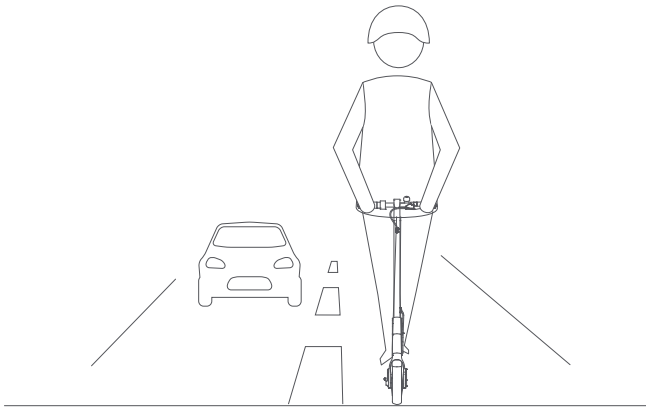

- ❌ Do not ride in traffic lanes or residential areas where vehicles and pedestrians are both allowed

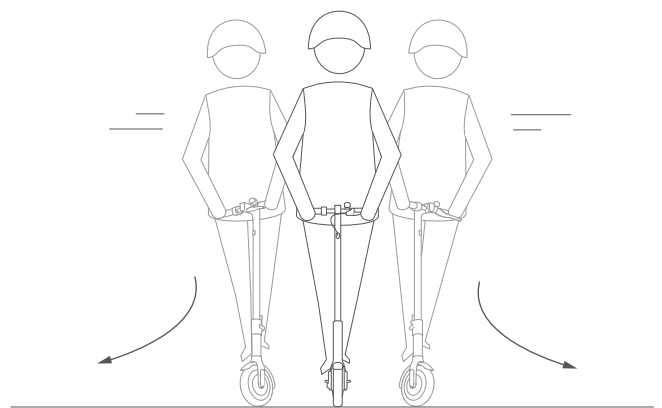

- ❌ Do not turn the handlebar violently during high-speed riding



- ❌ Do not ride through puddles or any other (water) obstacle. In such a case please lower your speed and bypass the obstacle.

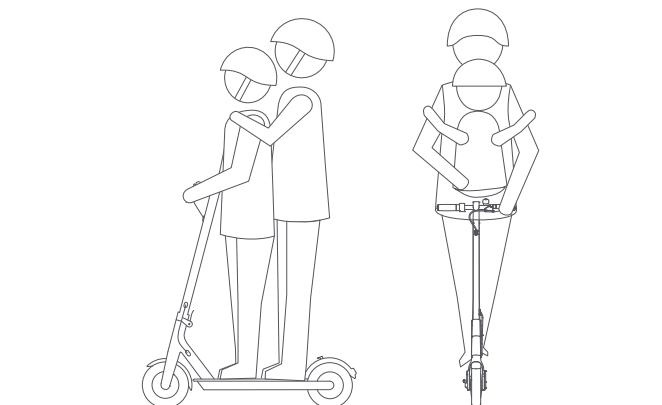

- ❌ Do not ride with anyone else, including children

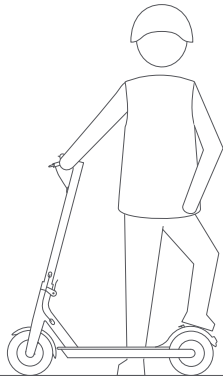

❌ Do not keep your feet on the rear mudguard

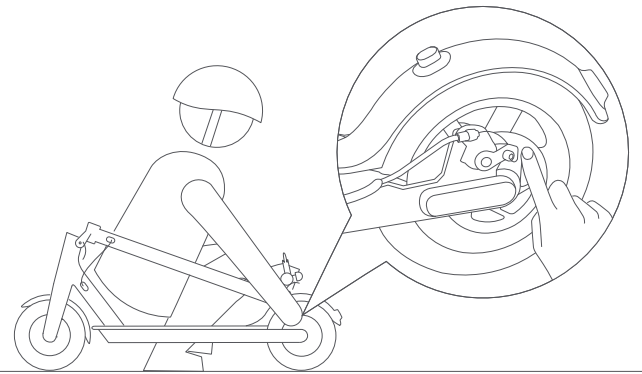

❌ Do not touch the disc brake



❌ Do not keep your hands away from handlebar

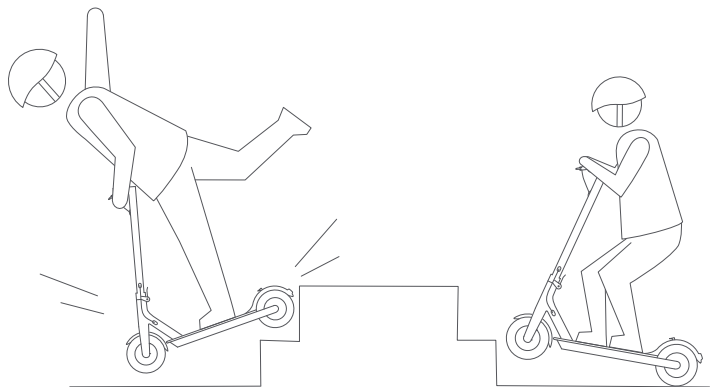

❌ Do not try riding up or down stairs, and jumping over obstacles

## Safety Reminder

- The scooter is intended for riders older than 16 years. Do not ride the scooter if you suffer from reduced physical, sensorial or mental capabilities. Riders with a lack of experience or knowledge should drive carefully. Children should not play with the Scooter or parts of it nor should cleaning or maintenance be done by children. The use of the machine results in the transmission of vibrations throughout the driver's body.
- This electric scooter is a leisure device. But once they're in a public area, they'll be seen as vehicles, subjecting to any risks faced by vehicles. For your safety, please follow instructions in the manual and traffic laws and regulations set forth by government and regulatory agencies.
- At the same time, you should understand that risks cannot be entirely avoided as others may violate traffic regulations and drive incautiously, and you're exposed to road accidents just as when you're walking or biking. The faster the scooter is, the longer it takes to stop. On a smooth surface, the scooter may slip, lose balance, and even result in a fall. Thus it is crucial that you use caution, keep proper speed and distance, especially so when you're unfamiliar with the place.
- Respect pedestrians' Right of Way. Try not to startle them while driving, especially children. When you ride from behind pedestrians, ring your bell to give them a heads-up and slow your scooter to pass from their left (applicable to countries where vehicles drive on the right). When you ride across pedestrians, keep to the right at a low speed. When you drive across pedestrians, keep the lowest speed or getting off the vehicle.
- Closely follow the safety instructions in the manual especially in China and countries that lack relevant laws and regulations regarding electric scooters. Xiaomi Communication Co., Ltd. shall not be liable for any financial losses, physical injuries, accidents, legal disputes and other interest conflicts resulted from actions that violate user instructions.
- Riding with high speed or a speed that is not appropriate or adequate for the situation (bad weather conditions, bad surface conditions, or the like) may lead into a potential loss of stability or loss of control. To reduce any risk, you must follow all instructions in this user manual. Be careful when mounting and dismantling the product, it may fall and cause injury.
- Do not lend your scooter to whoever knows not the operations. And when you do lend it to your friends, please take the responsibility to ensure he/she knows the operation and wears the safety gear.
- Check the scooter before every use. When you note loosen parts, low battery alerts, flat tires, excessive wear, strange sounds, malfunctions and other abnormal conditions, stop riding immediately and call for professional support.
- When riding a scooter, you need to hold the handle with both hands to avoid shaking and falling down.

- Always place the scooter on its stand on a flat and stable surface. The scooter must be placed with the stand against the slope to prevent it from tipping over. Never place the scooter with the front facing down the slope, as the stand may close and tip the machine. Once the scooter is on its stand, check its stability to avoid any risk of falling (by slip, wind or slight jolt). Do not park the scooter in a busy area, but rather along a wall. If possible, always choose to park your scooter on flat ground.
- Wear a helmet, elbow pads and knee pads in case of a fall to avoid injury. Poor driving can lead to falls or serious accidents. Store the electric scooter indoors when not in use. Read the instruction manual and drive the electric scooter carefully. You should only operate the electric scooter after you have understood and applied all the safety rules. The scooter operator will be responsible for any damage or injury caused by failure to follow the instructions in the owner's manual. For a better driving experience, it is recommended to conduct a regular maintenance of the product. Refer to the user manual for more information. Please read the user manual before charging the battery. DO NOT drive in rain or puddles. Required age of driver: 16 to 50 years. Not allowed for children.
- Do not touch the brake system, it could cause safety injuries.
- To avoid inappropriate use, it is necessary to start coasting the scooter to activate the motor and the accelerator. When the scooter is stopped, the accelerator does not work.

**WARNING – Risk of Fire – No User Serviceable Parts.**

## 7. Folding and Carrying

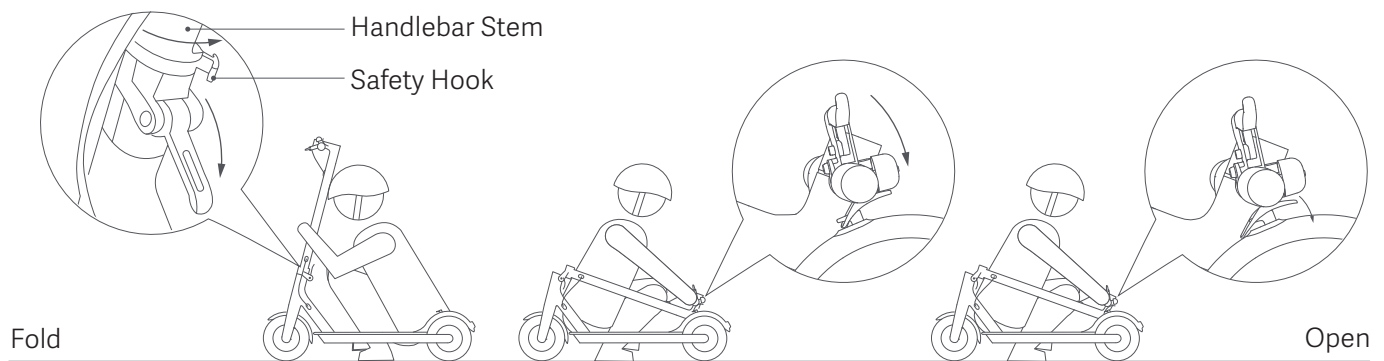

The scooter needs to be turned off before folding. Hold the handlebar stem, turn it counter-clockwise to open the safety hook and open the quick release lever. Align the bell and the buckle and hook them. When opening, disengage the bell lever from the buckle on the mudguard. Fold the handlebar stem up, close the quick release lever and turn the handlebar stem clockwise to close the safety hook.

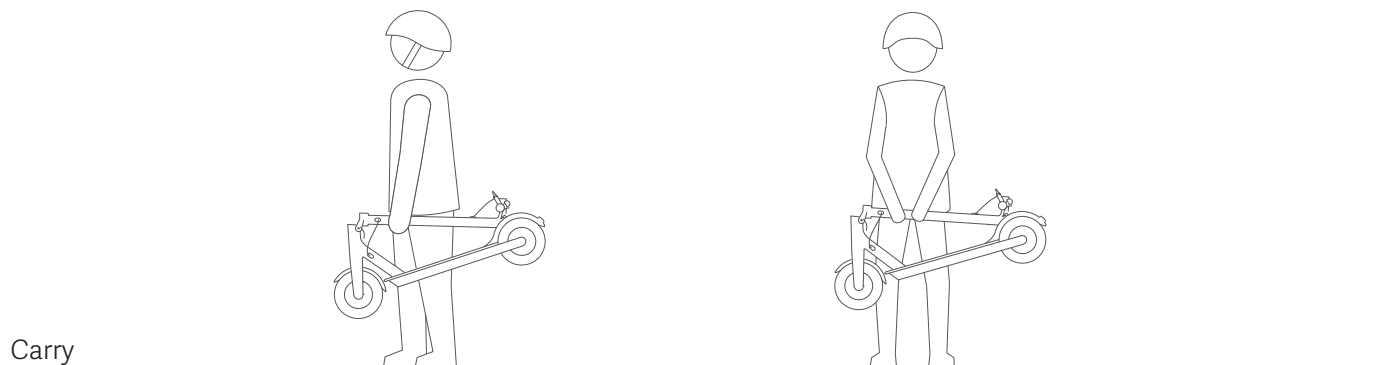

Hold the handlebar stem with either one hand or both hands to carry.

## 8. Daily Care and Maintenance

### Cleaning and storage

If you see stains on the scooter's body, wipe them off with a damp cloth. If the stains won't scrub off, put on some toothpaste, and brush them with a toothbrush, then wipe them off with a damp cloth. If you see scratches on plastic parts, use sandpaper or other abrasive materials to polish them.

Notes: do not clean the scooter with alcohol, gasoline, kerosene or other corrosive and volatile chemical solvents to prevent dire damage. Do not wash the scooter with a high-pressure water spray. During cleaning, make sure that the scooter's turned off, the charging cable is unplugged, and the rubber flap is closed as water leakage may result in electric shock or other major problems.

When the scooter's not in use, keep it indoors where it is dry and cool. Do not put it outdoors for long time. Excessive sunlight, overheating and overcooling accelerate tire aging and compromise the scooter and the battery pack's lifespan.

### Maintenance and removal of the battery

Maintenance and removal of the battery

Do not remove the battery. Removing the battery is complicated and can alter the operation of the scooter: You can contact an authorized repairer if the product is still guaranteed. If the product is not guaranteed you can contact any specialized repairer of your choice. You can ask for the list of the authorized repairers to the customer service available at [www.mi.com](http://www.mi.com). For any further question, you can contact the customer service available at [www.mi.com](http://www.mi.com).

Spare tires supplied with the product are to be mounted on the wheel by a professional repairer. Removing the wheels is complicated and incorrect assembly can lead to instability and malfunctions:

- Please contact an authorized repairer if the product is still under manufacturer guarantee. You can ask for the list of the authorized repairers to the customer service available at [www.mi.com](http://www.mi.com).
  - If the product is no longer under guaranteed You can contact any specialized repairer of your choice.
  - Should you have questions, you can contact Xiaomi's customer service available at [www.mi.com](http://www.mi.com).
1. Use original battery packs, use of other models or brands may bring about safety issues;
  2. Do not touch the contacts. Do not dismantle or puncture the casing. Keep the contacts away from metal objects to prevent short circuit which may result in battery damage or even injuries and deaths;
  3. Use original power adapter to avoid potential damage or fire;

4. Mishandling of used batteries may do tremendous harm to the environment. To protect natural environment, please follow local regulations to properly dispose used batteries.
5. After every use, fully charge the battery to prolong its lifespan.

Do not place the battery in an environment where the ambient temperature is higher than 50°C or lower than -20°C (e.g., do not leave the scooter or the battery pack in a car under direct sunlight for an extended time). Do not throw the battery pack into fire as it may lead to battery failure, battery overheating, and even another fire. If the scooter is expected to be left idle for more than 30 days, please fully charge the battery and place it in a dry and cool place. Keep in mind to recharge it every 60 days to protect the battery from potential damage which is beyond limited warranty.

Scooter shall be only be used with original batteries and charging of the Scooter shall only be done by the original charging adapter supplied with the Scooter (or any battery model or charging adapter model approved by the manufacturer as compatible).

Always charge before exhausting the battery to prolong the battery's lifespan. The battery pack performs better at normal temperature, and poor when it is below 0°C. For instance, when it is below -20°C, the riding range is only half or less at normal state. When the temperature rises, the riding range restores. For detailed information, please refer to Mi Home / Xiaomi Home App.

The external flexible cable of this transformer can not be replaced; if the cord is damaged, the transformer must be discarded and replaced by a new one. Should you have questions, you can contact Xiaomi's customer service available at [www.mi.com](http://www.mi.com).

Note: fully charged Mi Electric Scooter will last for 120-180 days. The built-in intelligent chip will keep a log of its charging and discharging records. The damage caused by prolonged no charge is irreversible and is beyond limited warranty. Once the damage is done, the battery can not be recharged (non-professionals are forbidden to dismantle the battery pack, as it may cause electric shock, short circuit or even major safety accidents).

In case of accident or breakdown: please contact an authorized repairer if the product is still under guarantee. If not, you can contact any specialized repairer of your choice. You can ask for the list of the authorized repairers to the customer service available at [www.mi.com](http://www.mi.com). For any question, please contact Xiaomi's customer service available at [www.mi.com](http://www.mi.com).

Efforts have been made to simplify wording in the user manual for users. When an action appears too complicated for a user, the user is advised to contact an authorized or a specialized repairer or Xiaomi's customer service.



## Adjusting the disc brake

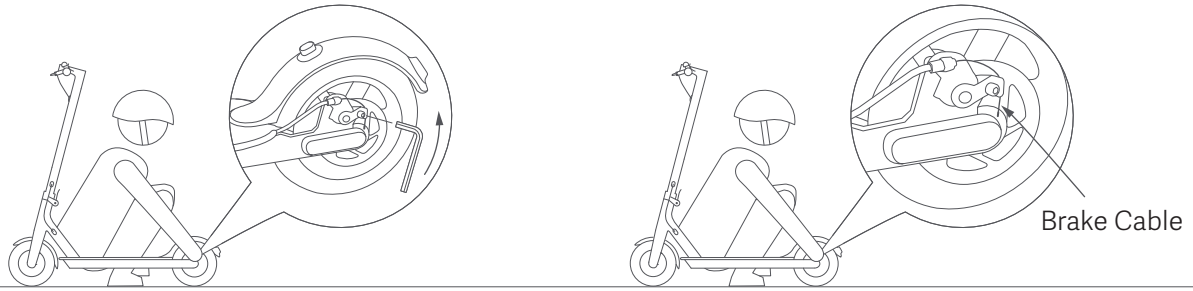

If the brake is too tight, use the M4 hexagon wrench to loosen the screws on the caliper, and slightly send back the brake cable to shorten the exposed length, then tighten the screws. If the brake is too loose, loosen the screws, and slightly pull out the brake cable to lengthen the exposed length, then tighten the screws.

## Adjust the handlebar

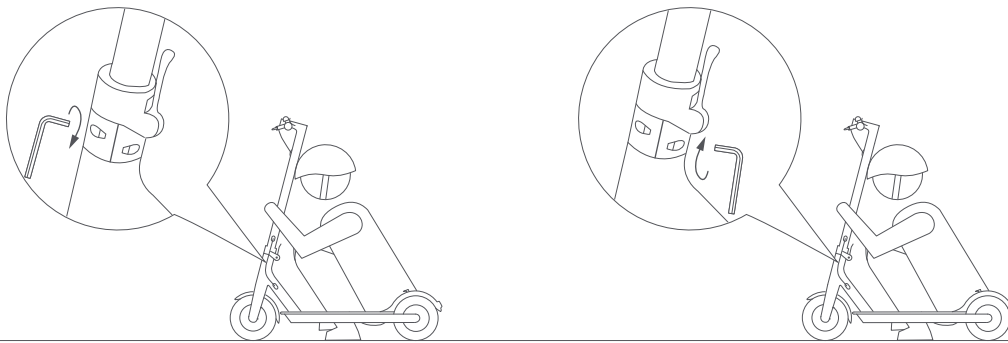

If the handlebar and its stem sway during riding, use the M5 hexagon wrench to tighten the screws on the folding mechanism.

## How to use the extended nozzle adapter

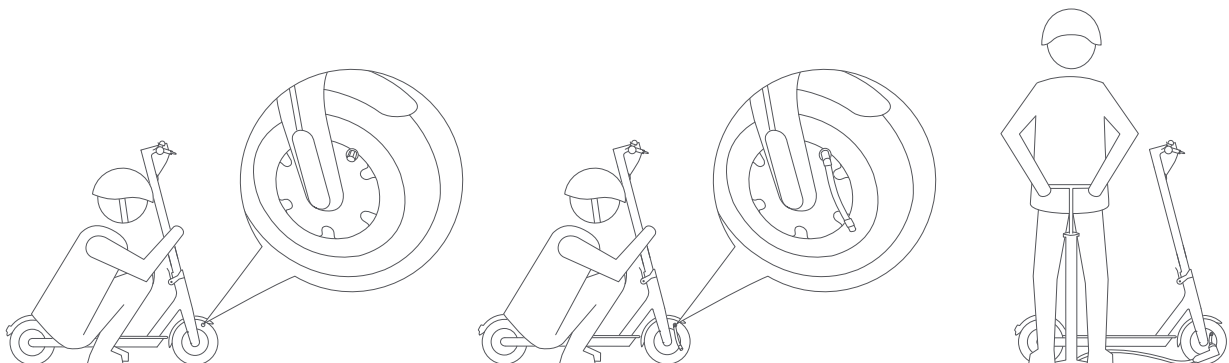

If your tires are flat, remove the screw-on cap from the valve, and connect the extended nozzle adapter to the valve for pumping up.

## 9. Specifications

Performance index	Items	Specifications
Dimensions	L × W × H <sup>[1]</sup> (cm)	108×43×114
	After folding: L × W × H (cm)	108×43×114
Weight	Item weight (kg)	Approx. 12.2
Riding requirements	Load range (kg)	25-100
	Age	16–50
	Body length (cm)	120–200
Main parameters	Max. speed (km/h)	Approx. 25
	General range <sup>[2]</sup> (km)	Approx. 30
	Max. climbing angle (%)	Approx. 14
	Suitable surfaces	Cement, asphalt and mud roads; bench lower than 1cm; crevice narrower than 3cm
	Operating temperature (°C)	-10–40
	Storage temperature (°C)	-20–45
	IP rating	IP54
Battery pack	Rated voltage (VDC)	36
	Max. input voltage (VDC)	42
	Rated capacity (Wh)	280
	Intelligent battery management system	Unusual temperature/short circuit/under voltage/over current/dual overcharge/dual over-discharge protections
Wheel Motor	Rated power (kW)	0.25
	Max. power (kW)	0.5
Charging adapter	Output power (kW)	0.071
	Input voltage (VAC)	100–240
	Output voltage (VDC)	42
	Output current (A)	1.7
	Charging time (h)	Approx. 5
Tire	Outer tires	Material: Natural rubber, synthetic rubber + cord Size: 8-1/2*2.0
	Inner tires	Material: Butyl rubber Size: 8-1/2*2.0 A/V straight nozzle

[1] Item height: from the ground to the top of the scooter;

[2] General range: measured when it is no wind and at 25°C, the scooter's fully charged to ride at a even speed of 15 km/h on a flat surface with a load of 75 kg.

Note: data and specifications may vary due to different models, and are subject to change without notice.

## 10. Trademark and Legal statement

**MI** is the trademark of Xiaomi Inc. All rights reserved. Ninebot is a registered trademark of Ninebot(Tianjin) Technology Co., Ltd., all other trademarks and trade names are those of their respective owners.

© 2017 Ninebot (Beijing) Technology Co., Ltd. All rights reserved.

This manual included all functions and instructions when it is printed. But actual product may vary due to improved functions and design. Please scan the QR code in the back cover for latest user manual.

Principal: Xiaomi Communications Co., Ltd.

Manufacturer: Ninebot (Changzhou) Tech Co., Ltd.

Address: 16F-17F, Block A, Building 3, No.18, Changwu Mid Rd, Wujin Dist., Changzhou, Jiangsu, China.

## 11. Certifications

Federal Communications Commission (FCC) Compliance Statement for USA

This device complies with part 15 of the FCC rules. Operation is subject to the following two conditions: (1) This device may not cause harmful interference, and (2) this device must accept any interference received, including interference that may cause undesired operation.

Note: This equipment has been tested and found to comply with the limits for a Class B digital device, pursuant to part 15 of the FCC Rules. These limits are designed to provide reasonable protection against harmful interference in a residential installation. This equipment generates, uses and can radiate radio frequency energy and, if not installed and used in accordance with the instructions, may cause harmful interference to radio communications. However, there is no guarantee that interference will not occur in a particular installation. If this equipment does cause harmful interference to radio or television reception, which can be determined by turning the equipment off and on, the user is encouraged to try to correct the interference by one or more of the following measures:

- Reorient or relocate the receiving antenna.
- Increase the separation between the equipment and receiver.
- Connect the equipment into an outlet on a circuit different from that to which the receiver is connected.
- Consult the dealer or an experienced radio/TV technician for help.

This equipment complies with FCC radiation exposure limits set forth for an uncontrolled environment.

### Industry Canada (IC) Compliance Statement for Canada

This device complies with Industry Canada license-exempt RSS standard(s). Operation is subject to the following two conditions: (1) this device may not cause interference, and (2) this device must accept any interference, including interference that may cause undesired operation of the device.

CAN ICES-3 (B)/NMB-3(B)

Ninebot is not responsible for any changes or modifications not expressly approved by Ninebot. Such modifications could void the user's authority to operate the equipment.

For model: M365  
FCC ID: 2ALS8-NS9633  
IC : 22636-NS9633

## Important WEEE information



WEEE Disposal and Recycling Information Correct Disposal of this product. This marking indicates that this product should not be disposal with other household wastes throughout the EU.

To prevent possible harm to the environment or human health from uncontrolled waste disposal, recycle it responsible to promote the sustainable reuse of materials resources. To return your used device, please use the return and collection systems or contact the retailer where the product was purchased. They can take this product for environmental safe recycling.

## Battery recycling information for the European Union



Batteries or packaging for batteries are labeled in accordance with European Directive 2006/66/EC concerning batteries and accumulators and waste batteries and accumulators. The Directive determines the framework for the return and recycling of used batteries and accumulators as applicable throughout the European Union. This label is applied to various batteries to indicate that the battery is not to be thrown away, but rather reclaimed upon end of life per this Directive.

In accordance with the European Directive 2006/66/EC, batteries and accumulators are labeled to indicate that they are to be collected separately and recycled at end of life. The label on the battery may also include a chemical symbol for the metal concerned in the battery (Pb for lead, Hg for mercury, and Cd for cadmium). Users of batteries and accumulators must not dispose of batteries and accumulators as unsorted municipal waste, but use the collection framework available to customers for the return, recycling, and treatment of batteries and accumulators. Customer participation is important to minimize any potential effects of batteries and accumulators on the environment and human health due to the potential presence of hazardous substances.

Before placing electrical and electronic equipment (EEE) in the waste collection stream or in waste collection facilities, the end user of equipment containing batteries and/or accumulators must remove those batteries and accumulators for separate collection.

## Restriction of Hazardous Substances (RoHS) Directive

This Ninebot (Changzhou) Tech Co., Ltd. product, with included parts (cables, cords, and so on) meets the requirements of Directive 2011/65/EU on the restriction of the use of certain hazardous substances in electrical and electronic equipment ("RoHS recast" or "RoHS 2").

## Radio Equipment Directive



Hereby, Ninebot (Changzhou) Tech Co., Ltd, declares that the wireless equipment listed in this section are in compliance with the essential requirements and other relevant provisions of Directive 2014/53/EU.

## 12. Connect with Mi Home / Xiaomi Home App

This product works with Mi Home / Xiaomi Home app\*. Control your device with Mi Home / Xiaomi Home app.

Scan the QR code to download and install the app. You will be directed to the connection setup page if the app is installed already. Or search "Mi Home / Xiaomi Home" in the app Store to download and install it.

Open Mi Home / Xiaomi Home app, tap "+" on the upper right, and then follow prompts to add your device.

\* The app is referred to as Xiaomi Home app in Europe (except for Russia). The name of the app displayed on your device should be taken as the default.



Note: The version of the app might have been updated, please follow the instructions based on the current app version.