

EN

2021 V.04

SUPER73[®]



OWNER'S HANDBOOK
ASSEMBLY & MAINTENANCE

SUPER73-S2

WELCOME!

Please read this owner's handbook carefully before using your Super73 in order to become thoroughly familiar with the correct operation of your bike's controls, its features, capabilities, and limitations. This handbook includes safe riding tips, but does not contain any of the techniques and skills necessary to ride an electric bicycle safely.

Join the Supersquad community of riders wherever you are!

This is just the beginning of your adventure with us! We look forward to hearing about your experience and seeing you online on our social networks:

📷 [Instagram.com/super73](https://www.instagram.com/super73)
📺 [Youtube.com/c/super73](https://www.youtube.com/c/super73)
📘 [Facebook.com/groups/Super73owners/](https://www.facebook.com/groups/Super73owners/)
Tag us! @super73 #Super73

CONTACT SUPER73

North America:

SUPER73, Inc.
16591 Noyes Ave, Irvine,
California 92606, United States
+1 (814) 747-9072

support.super73.com

Europe:

SUPER73
Industrieweg 61
1115 AD Duivendrecht, Netherlands
0031 (0)20 30 800 73

eu.super73.com

This handbook was drafted in the English language (Original instructions) and may have been translated into other languages as applicable (translation of Original instructions).

This handbook contains information on the Super73 electric bikes. Always store this owner's handbook with the Super73 and refer to it for information whenever necessary.

The information contained in this publication is based on the latest information available at the time of printing.

Please note all instructions and notices are subject to change and updates without notice. Please visit support.super73.com for periodic tech updates.

This is not to be reproduced wholly or in part without the written permission of Super73. ©Copyright 2021 Super73, Inc. , V.04. Updated 07/2021.





TABLE OF CONTENTS

Contact information.....	2
General information.....	5
Diagram of S2	6
Legal information.....	8
Intended use.....	8
Unpacking instructions	9
Assembly instructions.....	10
Registration.....	13
Pre-ride safety check	14
Operating the bike.....	15
Suspension adjustment guide.....	18
Super73 ride app.....	20
General warnings	21
Safety	23
Maintenance schedule	24
Maintenance and components	25
Warranty.....	30

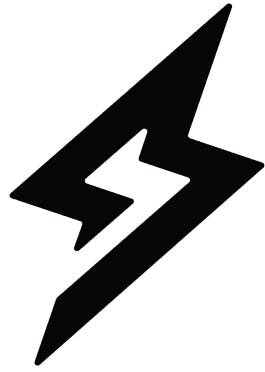

+ **MISSION STATEMENT** +

Super73 exists to create adventure and **community**. We strive to bolster adventurous exploration through **innovation**, create positive and forward-thinking experiences with **integrity**, and cultivate enthusiastic support and vision for the community.



GENERAL INFORMATION

Please note the following symbols:



WARNING!

Warnings, precautions, and potential risks associated with the use of your Super73.



DANGER!

Possible dangers for your life and health if respective calls to action are ignored.



TIP!

Recommendation! Meaningful additional information.

Please perform a safety check before each use, as described on in the “Pre-ride Safety Check” section on pg. 14 of this handbook.

If you feel uncertain about proper configuration after assembling your Super73 according to the provided assembly instructions, please contact your specialized retailer or Super73 directly.



If any of the instructions are beyond your skill set, we recommend taking your Super73 to a certified E-Bike specialist or professional cycle mechanic for assembly.



This owner’s handbook includes assembly and maintenance work which may need to be done at frequent intervals to maintain an operational and safe Super73. Never perform work on your Super73 beyond instructions in this handbook. This handbook is not intended as a comprehensive use, service, repair or maintenance handbook. Do NOT ride your Super73 if it has been assembled incorrectly. Maintenance beyond what the owner’s handbook instructs is to be handled by an E-Bike specialist or professional cycle mechanic. Riding an incorrectly assembled bike can put your own safety at risk as well as others.

DIAGRAM OF THE SUPER73-S2

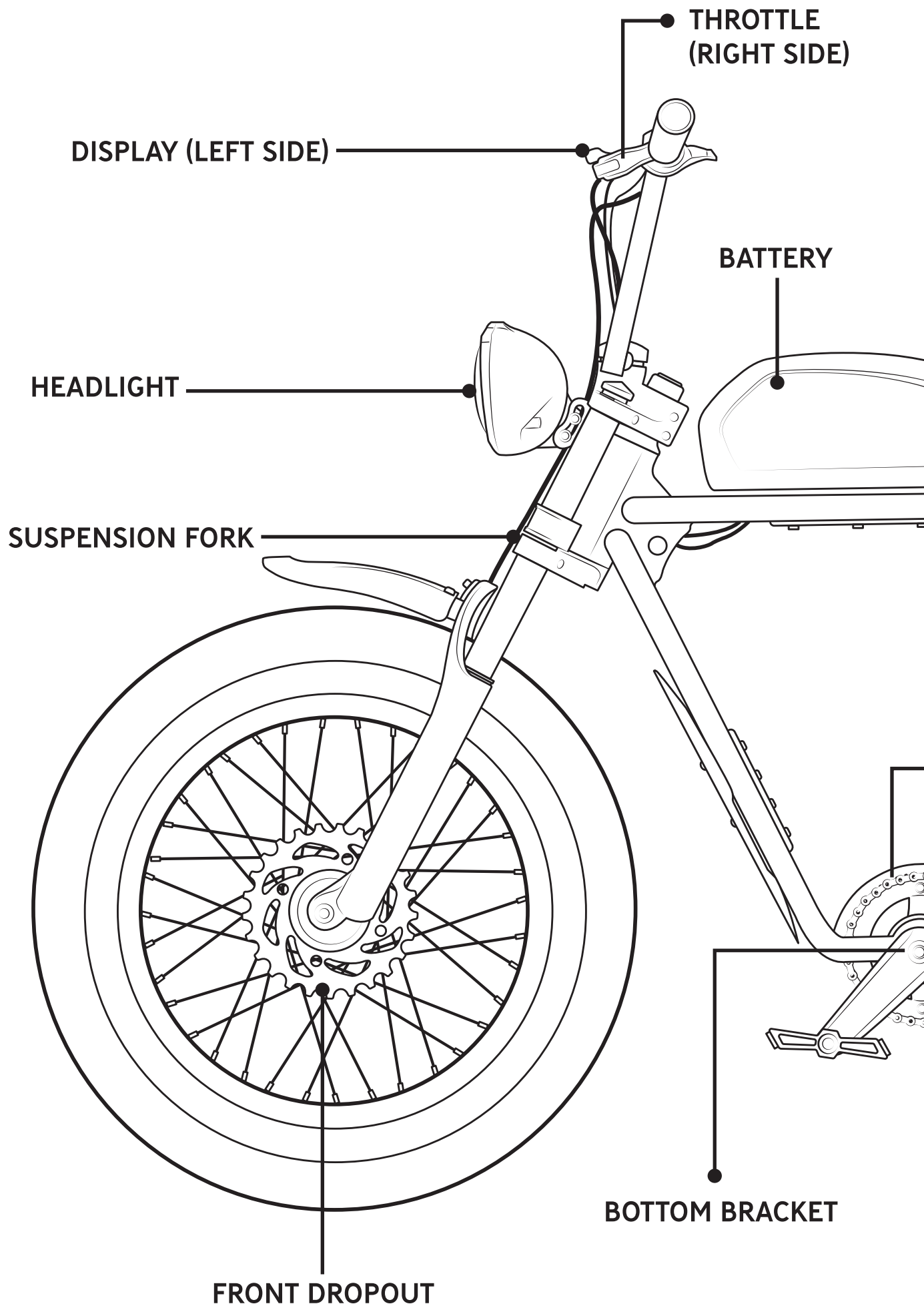

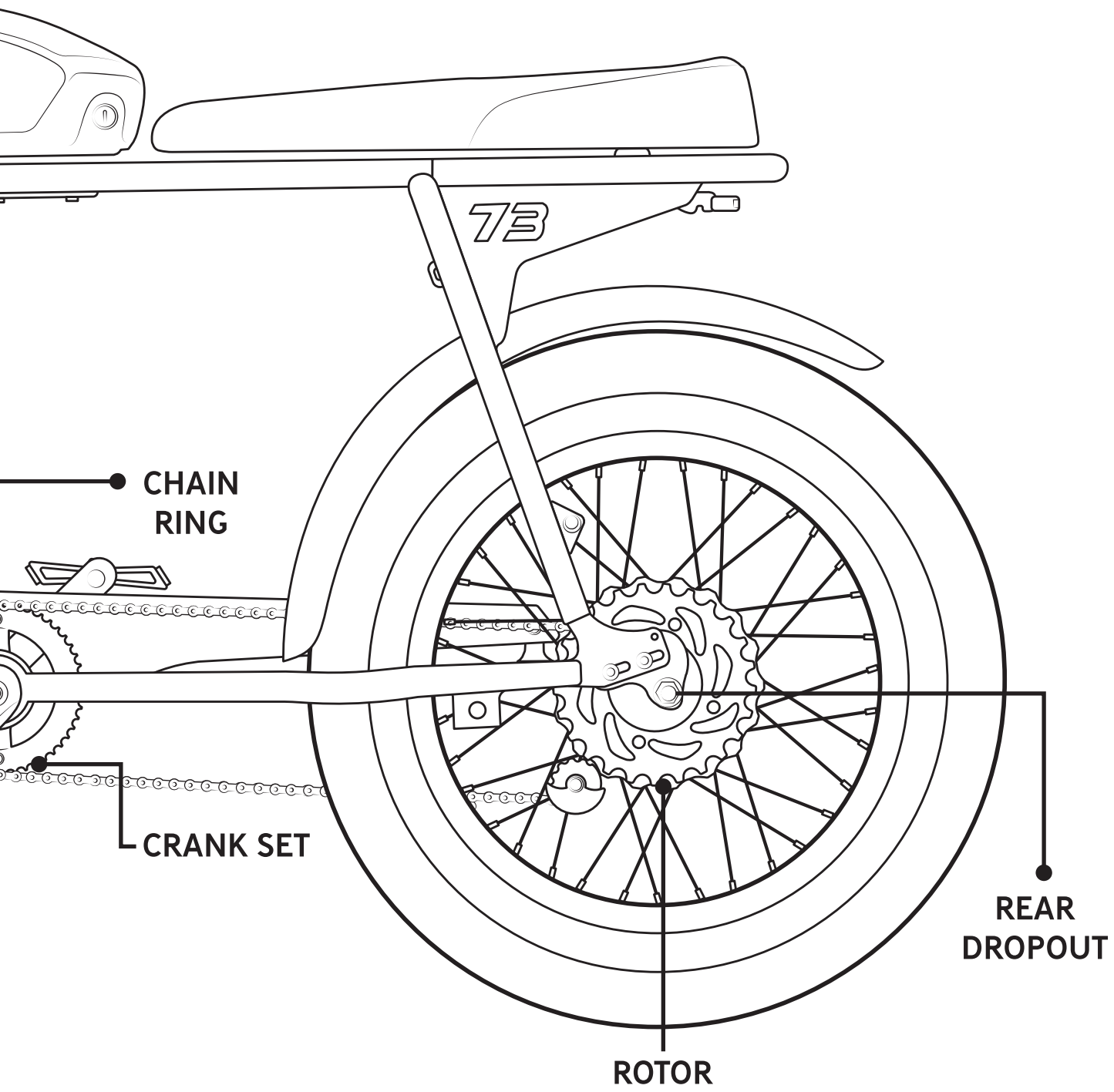

LEGAL REQUIREMENTS

Please check your country or state's regulations on electric bikes before riding. There are variations on age limit, speed, motor wattage, and road accessibility. Visit this website for more information: <https://super73.com/pages/laws-and-policies-for-e-bikes>

In most European countries and Australia, the rules of public traffic valid for bicycles also apply to e-bikes traveling up to 25 km/h. However, there are some notable differences (such as the age limit of the cyclist). More information here:

<http://bike-eu.com.s3-eu-central-1.amazonaws.com/app/uploads/2015/09/rules-regulation-on-electric-cycles-in-the-european-union-may-2017.pdf>

For the latest information on assembly and maintenance, please visit support.super73.com

INTENDED USE

No liability or warranty shall be accepted if the use of the Super73 deviates from this intended use, if safety instructions are not observed, in the event of overloading, or if faults are not properly rectified. Similarly, no liability and warranty shall be accepted in the case of assembly errors, willful intent, accidents, and/or if care and maintenance specifications are not followed. Any modification or alterations to the electrical system (tuning) voids all claims under warranty and guarantees.

- Your Super73 electric bike is designed for use on paved paths only. You should therefore never ride on stairs, jump, or perform wheelies or similar activities.
- Super73 electric bikes are not approved for participation in competitions.
- Commercial use does not form part of the intended use.
- Operation parameters, maintenance, guidelines, and service instructions described in this manual are part of the intended use.



Please observe the permitted overall weight of 325 lbs (147kg).



DANGER!

If the user rides the Super73 beyond its intended use, there may be a risk of an accident, serious injury, or death and the risk of injury to those around the user.

UNPACKING INSTRUCTIONS



DANGER!

Please read the instructions entirely before assembly to ensure the proper functioning of the Super73. Failure to do so could result in serious personal injury or damage to the bike.



VIDEO

View our assembly video to follow step-by-step instructions on our website at support.super73.com or scan the QR code!



- Do not open box from the top
- A second person is recommended to help unpack and assemble your Super73

1. Remove the 4 plastic tabs at the bottom of the package by pulling the D ring tab out causing the entire piece to pull out.
2. Remove the top lid of the box completely off the bike and bottom portion.
3. Locate the charger and assembly tool kit and set aside.
4. Open the cardboard tabs on the front of the lower portion of the box, lay the tire insert down, roll the bike out from the box, and engage the kickstand to prepare bike for assembly.
5. Please **read all assembly instructions in full** before beginning the build of your new bike.



If any serious damage has occurred to your Super73 during transit, please submit photos to Super73 directly by submitting a request at support.super73.com.

IN THE PACKAGING

- 1 x lithium-ion battery
- 2 x keys for the battery
- 1 x battery charger
- 1 x set of pedals
- 1 x two-sided open-end wrench with 15mm and 13mm ends
- 1 x 5mm hex wrench

ADDITIONAL RECOMMENDED TOOLS:

- 2.5 mm hex wrench
- 4 mm hex wrench
- Shock pump with Schrader valve

GOOD TO KNOW:

- Bolts for the handlebars mount are M6 X 12mm socket head cap screws
- Right pedal has the letter "R" inscribed on it, the left pedal has the letter "L" inscribed on it.
- 5mm Allen key can also be used to adjust brakes.
- Tire tubes size is 20"x5" or 20"x4.5" for the rear and front tires with Schrader valve.



DANGER!

Before performing any work on your Super73, turn off the power system and remove the battery. Be sure to also turn off the power system and remove the battery during transport in a vehicle. Involuntary activation of the electrical assistance system presents a risk of damage or injury.

ASSEMBLY INSTRUCTIONS



DANGER !

Do not ride with a bike that has not passed 100% safety verification before each ride as described in the section pre-ride safety check on pg. 14.

I. HANDLEBAR INSTALLATION

- Use the **5mm hex wrench** to remove the bolts of the handlebar clamp.
- Once the clamp is open, place the lower crossbar of the handlebar in the groove of the top crown.
- Loosely tighten the handlebar clamp with the **5 mm hex wrench**, and adjust the angle of the handlebar to riders comfort.
- Cross tighten the handlebar clamp from corner to corner making sure the clamp is tight and handlebars do not move.



2. INSTALL PEDALS

- A. Install and tighten the pedals using the **15 mm open wrench**. Look for a letter marking "L" "R" on each respective pedal and make sure you install the left pedal on the left crank, the right pedal on the right crank.
- B. The right pedal is screwed on in a clockwise direction. The left pedal is screwed on by turning it counter-clockwise.

TIP You may also use a **6mm hex wrench** at the tip of the pedal threading.

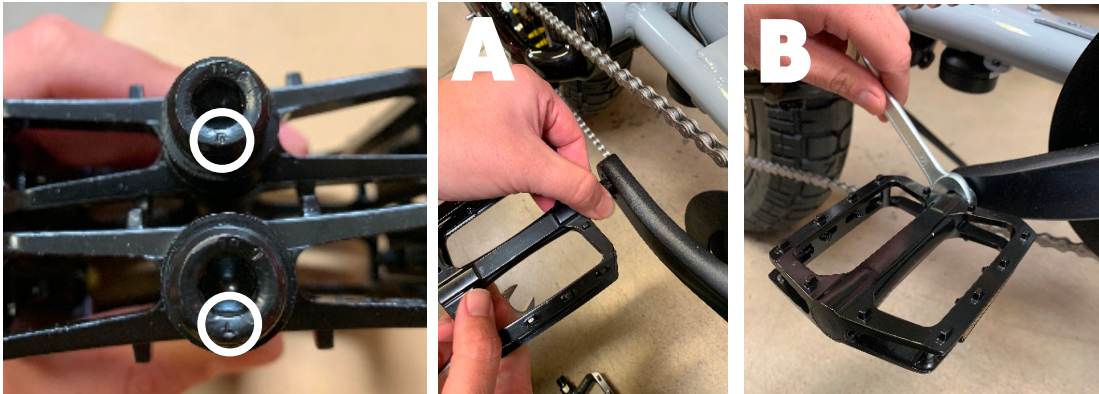

3. TIRE INFLATION

For transport purposes, tires are packed partially inflated. Tires must be inflated using a pump with a Schrader valve tip to a recommended 27 - 30 psi (1.86 - 2.06 bar).

- A. Inflate the tube to a max pressure of 35 PSI in order to ensure the tire is properly seated in the rim.
- B. Once properly seated, deflate to a recommended 27 - 30 PSI (1.86 - 2.06 bar). PSI will vary based on the weight of rider and type of terrain.

TIP The inner tube size is 20"x5" or 20"x4.5" for the rear and the front.



5. CHARGE THE BATTERY



We recommend charging the battery for 6-8 hours on the first charge. This will help condition the lithium-ion cells for optimal performance.

The battery can be charged both mounted on the bike or separately from the bike. Two keys are supplied to unlock and lock the battery.

- A. Plug in the charger into a 120v wall outlet. (220v EU)
- B. Connect the charger cable to the battery charging port.
- C. Turn the battery on by pressing the power button. The battery is on when the power button is illuminated. The battery will not charge unless it is switched on.
- D. The throttle is disabled during the charge sequence and a charge icon will show on the display during the charging process.

When the charging process starts, the charger LED turns red. Once the battery is charged, the LED turns green.

- A. Turn the battery off.
- B. Remove the charger cable from the battery charging port.
- C. Remember to put the protective cap back onto the battery charging port after charging to protect it from dirt and moisture.
- D. Unplug the charger from the socket.



Always make sure there is plenty of ventilation and a dry, fireproof environment for the charger and follow these operating instructions.

- Do not leave the battery connected to the active charger for more than 48 hours.
- Do not leave the charger connected to a socket for more than 48 hours.
- Charge the battery and use the bike at least once every 90 days.
- Do not store the bike for more than 24 hours with an empty battery. This prevents a deep discharge with irreparable consequences from occurring.
- Do not use the charger if the charger, main cable or connector cable have any visible signs of damage.
- After the battery is fully charged, the battery power button light will turn off and the charger indicator light will turn back to green. Nevertheless, make sure that the battery is not connected to the charger for more than 48 hours.



More information on battery care and range in the Maintenance and Components section on pg. 27 of this handbook.

Battery Range

Power output will vary depending on battery capacity. If your battery is at 20%, for example, it won't have as much power as a fully charged battery. If your Super73 has been shipped to you along with the battery, please fully charge the battery first. When a battery leaves the factory, it's not fully charged as required by international air and sea legislation. Battery is fully charged when the LED light on the charger is green.



More information on range and performance in Maintenance and Components section of this manual on pg. 28.

ASSEMBLY IS FINISHED!



You're almost ready to ride. Your Super73 should look like below. **Before your first ride,** please verify your bike is safe to ride using the Pre-ride safety check on pg. 14.



REGISTER YOUR SUPER73



All original owners must register on our website to validate your warranty.

Please register online at: <https://www.super73.com/pages/register> or scan the QR code.



If you are unable to register online, please call us at +1 (814) 747-9072 for assistance in registration. Write down below the following information for future reference:

Location or website of purchase: _____

Date of purchase: _____

Model name: ZX

Bike Serial #: _____

(Engraved on the side of the bottom bracket in between the pedal cranks)

Battery Serial #: _____

Battery Key #: _____



We recommend that you keep your original receipt with this handbook.

PRE-RIDE SAFETY CHECK



DANGER!

Use the following checklist before each ride to verify your bike is safe to ride.

Never operate your bike and use your app simultaneously.



Make sure the brakes have already been applied before getting on to your bike. If the assistance mode is turned on, your E-Bike will start moving as soon as you push on the pedal. The unfamiliar push can otherwise cause a fall, hazard, or accident.

CHECKLIST:

1. WHEELS

- Check the condition of both tires making sure the tread is in good condition free from punctures, cracks, and deformations.
- Maintain proper tire pressure. We recommend a range of 27 - 30 psi (1.86-2.06 bar) dependent on the weight of rider and type of terrain.
- Ensure wheels are true and properly dished.

2. BATTERY

- Check that the battery is inserted securely: push the battery into its holder until it clicks into the lock. Remove the key from the lock and pull the battery to check if it has indeed locked into place.
- Check the charge status of the battery. Familiarize yourself with battery charging and storage best practices.



More information on battery maintenance in our maintenance & components section of this handbook on pg. 27.

3. BRAKES SYSTEM

- Pull both brake levers. You should feel an obvious pressure point and the levers should not be able to touch the handle.



More information on brakes in our Maintenance & Components section on pg. 26 of this handbook.

4. LIGHTING

- Check if the front and rear lights are working properly. Do not cover any lighting or reflectors. (if applicable)

5. CABLES

- Look out for any loose cables.
- Make sure the male and female plugs are properly connected.
- There should be no strain on any wiring near the fork when turning the handlebars from left to right.
- Verify that the wiring on the frame is secure and free from any moving parts that may damage the wiring. This includes any wires and brake cable lines near the wheel or other moving parts.

6. DISPLAY

- Check that your display turns on and functions properly.

7. KICKSTAND

- Make sure that the kickstand is tightly secured, and not rubbing against the ground or tires.



Do not sit on a bike with a kickstand engaged.

OPERATING THE BIKE



DANGER!

Batteries that have not been fully inserted and locked can come loose during a ride and fall off. This may cause damage to the battery case and may cause a crash or injury.



DANGER! Do not place the key inadvertently or any other metal object into the charging port as this can result in a short circuit and render your battery nonchargeable and in need of replacement. This will void the warranty.



Do not sit on a bike with a kickstand engaged.

I. POWERING THE BIKE ON



- Disengage the kickstand, grab the brake handle to engage the brakes, and seat yourself on the Super73.
- Press the battery power button to turn the bike on.
- Once the display screen is illuminated, the bike is on and you're ready to ride!

2. CHANGING THE INFORMATION VIEWED ON THE DISPLAY



- Quick press "O" button to toggle the information viewed on the display.
 - Speed (mph)
 - Range (miles)
 - Assist (0-4)
 - Total (miles)

3. OPERATING LIGHTS



- The Super73 S2 model comes equipped with a front headlight and rear brake light.
- To activate the front headlight, press and hold down the up "∧" button on the display until the light illuminates. Follow the same step to turn off the lights.
- The rear brake light will automatically illuminate when the headlight is powered on. The rear light will get brighter when the brake levers are engaged whether the headlight is on or off.

4. PEDAL ASSIST



- To select your pedal assist mode, follow these steps once the display has been turned on and you are seated on the Super73:
- Press on the menu "O" button briefly to switch between display views until "Assist" appears on the screen.
- Press the up "^" button to increase the pedal assist level. To decrease the assist level, press the down "v" button. Pedal assist ranges from 1-4, with 0 meaning pedal assist is turned off. The higher the level, the more electric assistance you'll get, and the less you'll have to pedal.
- Level 1 (ECO) - 25% Speed Power
- Level 2 (TOUR) - 50% Speed Power
- Level 3 (SPORT) - 75% Speed Power
- Level 4 (SUPER) - 100% Speed Power
- Once you begin pedaling, the pedal assist sensor will activate the motor and you will begin to accelerate to the selected assist level.
- The display will revert to the previous viewing mode after desired assist level is chosen.

5. BRAKING



- The brake levers are equipped with sensors that cut power to the motor when either of the levers are compressed. The S2 employs a hydraulic brake systems. The right lever will activate the rear brakes when compressed and the left lever will activate the front brakes when compressed.
- The Super73 brake orientation is as follows:
Rear brake = right lever
Front brake = left lever

6. SETTINGS MENU



- Hold down the "O" button on display to activate the settings menu.
- Settings parameters:
 - Contrast (display window contrast 0-100)
 - Units (standard is set to mi/F)
 - Position (changes the orientation of display if it is on the left or right side of the bike)
 - Backlight (display backlight power 0-100)
 - Version is the software version of the system.
 - Coin is the battery level inside display.

7. CHANGING RIDING MODES

- Your Super73 is equipped with multi-class mode selection. The bike defaults to a Class 2 mode. It is the rider's responsibility to follow local E-bike regulations. Be sure you are up to date with your local motor vehicle codes.

TIP You can find links to more information on E-bike regulations in the Legal Requirements section on pg. 8 of this handbook.

- To change the riding mode, follow instructions detailed in the mobile app controlling your display.
- Once in the app, you can change between the following riding modes:
 - Class 1 - pedal assist only at 20 mph max speed.
 - Class 2 - throttle operation and pedal assist at 20 mph max speed.
 - Class 3 - pedal assist only, at 28 mph max speed.
 - Unlimited - up to 2000 watts of power and throttle speeds above 28mph**This mode is exclusively for riding off public roads and on private property.

TIP More information on switching through multi-class modes in the app section on pg. 20 of this handbook.

8. TURNING OFF THE BIKE

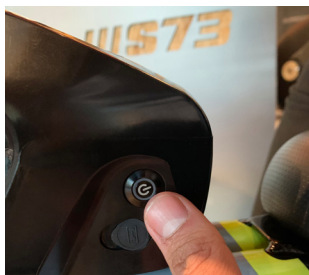

- When you are done riding your Super73 it is important to turn off the power properly.
- Turn off the bike by pressing the power button on the battery. The light on the power button should turn off when properly powered down. The bike is featured with automatic shut off when left idle for more than 5 minutes.
- You can charge the battery while it's on the Super73, or by removing the battery from the mount and charging it separately.

Suspension Adjustment Guide

The S2 defaults to a baseline setting. Follow the guides below to adjust the suspension to your desired comfort level. The S2 is equipped with an inverted coil-spring fork with air assist and the ability to adjust lockout and rebound damping.

 If any of the instructions are beyond your skill set, we recommend taking your Super73 to a certified E-Bike specialist or professional cycle mechanic for adjustments.

 Changing suspension adjustment can change the handling and braking characteristics of your Super73. Never change suspension adjustment unless you are thoroughly familiar with the suspension system instructions and recommendations, and always check for changes in the handling and braking characteristics of the Super73 after a suspension adjustment by taking a careful test ride in a hazard-free area.

Front Suspension Adjustments

Adjusting Air Assist Pressure

Adjustment of air assist pressure will require a shock pump. Use Figure I “suggested starting fork air pressure” on pg. 19 to find your recommended air pressure.



- Remove the valve cap on the top left stanchion and connect your shock pump to the pressure valve.
- Review the current air pressure and adjust according to Figure I. Fine tune the pressure with the shock pump to your desired comfort.
- Be sure you remove the shock pump in between adjustments as leaving it on can affect the active pressure in the suspension. After completing adjustment, reinstall the pressure valve cap.

Measuring Sag

The recommended sag of the front fork is 20mm into the travel, which can be measured with the bumper found on the lower portion of the right stanchion. To measure sag, place your bike somewhere level where you can safely put your full weight on the bike while balanced. It is recommended to have a friend help balance the bike during this portion of adjustment.



- Slide the bumper all the way down to the top of the air chamber. Then seat yourself on the bike, engage the brakes, and move into an aggressive standing position with your feet on the pedals.
- Dismount from the bike and measure the amount of travel between the bumper and the air chamber. If the measurement is more or less than 20mm, adjust the air assist pressure appropriately.

Adjusting Lockout

Lockout is adjusted with the dial on the top right stanchion.



- Turning the preload dial clockwise (+) will decrease compression on the suspension.
- Turning the dial counterclockwise (-) will increase compression on the suspension.

Adjusting Rebound

Rebound is adjusted with the dial located on the bottom of the right stanchion.



- Turn the rebound dial clockwise to slow your suspension rebound (damper increase).
- Turn the rebound dial counterclockwise to speed up the rebound (damper decrease).

 This table is not intended for use as a tire air pressure guide.

Figure I

SUGGESTED STARTING FORK AIR PRESSURE			
LBS	KG	PSI	BAR
125	57	70	4.8
145	66	78	5.4
165	75	86	5.9
185	84	94	6.5
205	93	102	7.03
225	102	110	7.6
245	111	118	8.1
265	120	126	8.7
285	129	134	9.2
305	138	142	9.8
325	148	150	10.3

Fork Pressure Limits
Minimum: 70 PSI
Maximum: 150 PSI

SUPER73 APP



Never ride and adjust settings on your app while in motion. Pull over and practice safe riding. By operating your bike and the app simultaneously you put yourself at risk for collision and serious injury.

Each S2 bike comes programmed in the Class-2 ride mode, which allows for throttle operation and pedal assist riding up to 20mph. This allows the S2 to be legally ridden on most bike paths without a license, insurance, or registration.

- Class 1 - pedal assist only at 20 mph max speed.
- Class 2 - throttle operation and pedal assist at 20 mph max speed.
- Class 3 - pedal assist only, at 28 mph max speed.
- Unlimited - up to 2000 watts of power and throttle speeds above 28mph**This mode is exclusively for riding off public roads and on private property.

For more information on using the Super73 App, please refer to the Super73 App page on our website.

GENERAL WARNINGS

Like any sport, cycling involves risk of injury and it is the rider's responsibility to assume potential risks and injury involved when riding. By choosing to ride a bicycle, you assume the responsibility for that risk. You need to know and practice the rules and safety regulations of riding this bicycle. Proper use and maintenance of your bicycle reduces risk of injury. Check your local state or country regulations for electric bike laws. For example, check the minimum age for using an electric bike as this differs in various regions.

Riders must have the physical condition, reaction time, and mental capability to ride and manage traffic, road conditions, and sudden situations. Also, respect the laws governing E-bike use in accordance with each region. If you have an impairment or disability (i.e. visual impairment, hearing impairment, physical impairment, cognitive/language impairment, seizure disorder, etc.), consult your physician before riding any bicycle.

NOTICE: Only take on tasks for which you have the necessary knowledge and tools. It is recommended that users pay special attention to all of the general operating rules below before operating their Super73 bike.

- When riding, obey the same road laws as all other road vehicles, including giving right of way to pedestrians and stopping at red lights and stop signs.
- For additional information, contact the road traffic authority, police department or Department of Motor Vehicles in your state or country.
- Use correct hand signals to indicate turning or stopping.
- Concentrate on the path ahead. Avoid potholes, gravel, wet or oily roads, curbs, train tracks, speed bumps, and other obstacles.
- Walk your bike across all train tracks.
- Expect the unexpected, such as opening car doors or cars backing out of driveways
- Be aware at intersections and when preparing to pass other vehicles or other cyclists.
- Familiarize yourself with all the bike features. Practice using the brakes and throttle.
- If you are wearing loose pants, secure the bottom using leg clips or elastic bands to prevent them from being caught in the chain.
- Wear proper riding clothes and avoid wearing open-toe shoes.
- Don't carry passengers or cargo that will interfere with your ability to control the bicycle.
- Never ride and use the app simultaneously. Pull over and adjust any settings or set your destination in the navigation in a safe spot.
- Don't use music devices such as headphones while riding. This will restrict your hearing and impair your awareness of your surrounding environment.
- Maintain a comfortable stopping distance from all other objects, riders, and vehicles. Safe braking distances are based on forces, such as weather and lighting conditions among other variables.

WET WEATHER

 It is recommended to not ride in wet weather. The Super73 is not meant for use in puddles, heavy rain, and streams. Never immerse this product in water as the electrical system may be damaged. Take extra care while riding in wet conditions. Feet or hands can slip in wet conditions and lead to serious injury from a fall. Brake earlier as it will take longer to slow than when operating in dry conditions. Decrease riding speed. Wear reflective clothing and use approved safety lights. Road hazards are more difficult to see when wet, proceed with caution.

RIDING AT NIGHT

 Be safe! It is recommended to not ride at night. Ensure your Super73 is equipped with a full set of correctly positioned and clean reflectors. Use a properly functioning lighting set comprised of a white front light and red rear light. Wear reflective and light-colored clothing. Slow down and use familiar roads with street lighting, if possible.

FOR PARENTS AND GUARDIANS

 As a parent or guardian, you are responsible for the activities and safety of your child. The Super73 is not designed for use by children under the age of 16. Obey local regulations and always wear a helmet.

REPLACEMENT PARTS

 Use only genuine parts from Super73 for safety-critical components including: Battery, motor, throttle, display, controller, DC-DC Converters, and lighting components, and wiring harnesses. Failure to do so could cause injuries, damage the bike, and invalidate the warranty.

 When replacing components such as tires, inner tubes, and brake pads, use only parts that comply with Super73 recommended specifications in sizing and quality as directed.

TAMPERING

 Do not in any way tamper with the electrical components of the Super73. Tampering includes opening the protective casing of the motor or battery, breaking any tamper evident seals, or any other modifications of the electrical system.

SAFETY

The following safety notes provide additional information on the safe operation of your Super73 and should be closely reviewed. Failure to review these notes can lead to serious injury or death.

- All users must read and understand this manual before first use. Additional manuals for components used on your bicycle may also be provided and should be read before use in addition to this manual.
- Always wear an approved bicycle helmet whenever using this product and ensure that all helmet manufacturer instructions are used for fit and care of your helmet. Failure to wear a helmet when riding may result in serious injury or death in the event of an accident.
- Ensure correct tightening and setup is performed on your bicycle after assembly.
- It is your responsibility to familiarize yourself with the laws and requirements of operation of this product in the area(s) where you ride.
- Ensure handle bar grips are not damaged and properly installed. Loose or damaged grips can cause you to lose control and fall.
- Off-road riding requires close attention and specific skills and presents variable conditions and hazards which accompany the conditions. Wear appropriate safety gear and do not ride alone in remote areas.
- Bicycles and bicycle parts have strength and integrity limitations and extreme riding should not be performed or you risk damaging the components or becoming seriously injured.
- After any incident you must consider your bike unsafe to ride until an inspection is made according to provided safety check in the is handbook. Consult with a professional cycle mechanic for a comprehensive inspection.
- Failure to properly charge, store, or use your battery will void the warranty and may cause a hazardous situation.
- Extreme care should be taken when using the pedal assist sensor and propulsion on this product. Ensure you understand and are prepared for the power assistance to engage as soon as pedaling is underway.
- The brake system is equipped with an inhibitor that shuts down the power to the electric motor whenever the brakes are engaged.
- User must understand the operation of the throttle and pedal assist levels before using, and take ample care in their usage at speeds appropriate for each region and user experience level. Use the lowest assist level until you are comfortable with the bike and feel confident in controlling the power.
- Because e-bikes are heavier and faster than normal bicycles, they require extra caution and care while riding.
- Do not remove the front, rear or pedal reflectors.
- Be familiar with your local e-bike laws.
- Any after-market changes to your Super73 bike not expressly approved by Super73 may void the warranty and create an unsafe riding experience.

MAINTENANCE SCHEDULE



DANGER!

Intensive use of the Super73 may cause possible damage to the frame and the fork. It is important to inspect the frame and the fork and look for signs of cracks. A broken or cracked frame and fork can cause an accident and injury. Refer to the Intended Use section on pg. 8.

In order to prolong the life expectancy of your bike, here is an example of a maintenance schedule, under intended use, that we recommend the following:

I. BEFORE AND AFTER EACH RIDE

- Check the alignment of the wheels.
- Check the state of charge of the battery.
- Check that brakes function properly.
- Check tires for any punctures.
- Store the bike carefully in a clean and dry place.
- Check that your kickstand is tightly secured.
- Check for loose cables or wires that may be strained when turning the front wheel from left to right.

2. EVERY MONTH

- Inspect the handlebar and steer tube for any unusual movement.
- Check the cables, tires, handles.
- Check the wear of brake rotors, brake pads, and replace them if necessary.
- Check the tension of the spokes, and ensure that the wheels are true and properly dished.
- Lube the chain and check the tension in the chain.
- Inspect suspension components for wear and make any necessary adjustments.

3. EVERY SIX MONTHS (depending on frequency and type of use)

- Inspect the frame, fork and look for signs of cracks in the metal.
- Check the bottom bracket and crankshaft and tighten the bolts on each crank.
- Check and grease the wheel hubs, headset, all parts in friction.
- Grease suspension components and tighten any necessary hardware.



For your own safety, if any of the recommended maintenance procedures are not within your skill set, we advise taking your Super73 to an E-bike specialist or professional cycle mechanic for inspection.

WASHING AND CARING FOR YOUR BIKE

Dirt, salt, and other elements can damage your bike. Regularly clean your Super73 and protect it against corrosion. Use clear water for cleaning and a gentle soap if necessary to dissolve grease and other residues. Do not spray water directly onto your Super73. Instead, use a lightly damp cloth to wipe down any dirt or debris. After drying your bike, treat surfaces with a care product. Finally, wipe all parts with a clean, soft cloth.



Do not clean your Super73 with a strong water jet or steam jet from a short distance. The water can get past the seals and get inside the bearings. Lubricants are then diluted, increasing friction. In the long run, the bearing surfaces will deteriorate.

MAINTENANCE & COMPONENTS



DANGER!

Before performing any work on your Super73 electronics system, turn off the system and remove the battery. Involuntary activation of the Super73 system poses a risk of injury.

TIRES / WHEELS

The S2 has tire sizes of 20" x 5" (rear) and 20" x 4.5" (front) rubber tires with inner tubes and a rim liner. The tube size for both the front and rear tires is 20" x 5". The tires are designed for durability and safety for regular cycling activities. However, tires must be checked before each use for proper inflation and condition.

Proper inflation, good maintenance, and quick replacement will help ensure that the operational characteristics of your bike will be maintained and dangerous conditions avoided.

Tires must be inflated using a pump with a Schrader valve tip with a recommended pressure between 27 and 30 psi (1.86 -2.06 bar). Check the condition of the tires and rims for damage, cracks, or deformation. The minimal tightening torque of the wheel nuts is 16ft/lb (21.69 Nm).

It is essential that the proper air pressure is maintained in the tires all the time. Do not under-inflate or over-inflate your tires. Low pressure can cause loss of control and tires that are too inflated can burst. Failure to maintain proper air pressure rating indicated in the handbook may at any time result in tire and / or wheel failure.

Inflate your tires from a regulated air source with an available manometer. Inflating your tires with an unregulated air source could over-inflate them, resulting in an exploded tire. When tire wear becomes obvious or a hole in the tire is found, you must replace the tires and / or tubes before using the bike, otherwise injury to operators and / or damage to your bike could occur.

In addition to proper inflation, correct wheel alignment helps to decrease tire wear. If you find a tire is worn unevenly, have a professional cycle mechanic check the wheel alignment.

HELMETS / REFLECTORS

A properly fitting ANSI or SNELL, (or CE if you are located in Europe), approved bicycle safety helmet should be worn at all times when riding your bicycle, or recommended per your local laws. Always wear a properly fitted helmet that covers the forehead when riding a bicycle. Many states require specific safety devices. It is your responsibility to familiarize yourself with the laws of the state where you ride and to comply with all applicable laws, including properly equipping yourself and your bike as the law requires.

Reflectors are important safety devices that are designed as an integral part of your bicycle. Federal regulations require every bicycle to be equipped with front, rear, wheel, and pedal reflectors. These reflectors are designed to pick up and reflect street-lights and car lights in a way that helps you to be seen and recognized as a moving bicyclist. Check reflectors and their mounting brackets regularly to make sure they are clean, straight, unbroken, and securely mounted.

BRAKES



Brakes are an integral part of the operation of your bike and must be properly maintained, adjusted, and replaced. If any of the below is not within your skill set we recommend taking your bike to an E-bike specialist or professional cycle mechanic.



The hydraulic brake system requires maintenance on the pads, rotors, and also on the hydraulic brake line. Always verify that your brakes are in good condition in order to maintain safe riding.

For optimum braking performance, Super73 bikes are equipped with Tektro hydraulic disc brakes. See video on our website on how to adjust: www.super73.com/pages/owners or Tektro brake adjustment manuals on www.tektron.com.

The Super73 brake orientation is as follows:

Rear brake = right lever

Front brake = left lever

Brake Models:

Model S2: <https://www.tektron.com/products.php?p=242>

Brake pads:

Model S2: <https://www.tektron.com/products.php?p=226>

On a hydraulic disc brake, pad wear is compensated automatically. Simply check the alignment of the pads with the disc, and check that the wheel is fully pushed back. Good alignment ensures the absence of noise and a normal wear of the pads.

To ensure maximum service life of the brake components, avoid contamination of the pads and the disc by greasy substances.

Regularly check the condition of your cables, ducts or harness and the wear of your pads. Some discs are only compatible with "resin" pads. Do not use a metal pad with discs marked "Resin".

For better ergonomics and safety, we advise you to adjust the brake levers in a position that places it as a natural extension of the user's arms. If you have any questions or concerns, please contact Super73.

NEW BRAKE PAD & ROTOR BED-IN PROCESS

Any time you replace your brake pads, rotors, or both, it is important they are properly bedded for optimal performance. To bed your brakes properly after replacement, accelerate your bike up to 20mph and then engage your brakes to bring the bike to a near stop, and then repeat the process up to 8-10 times. This process allows your pads to wear evenly as well as remove surface glaze and contamination from installation.

REPLACING THE PADS

When pads are worn, make sure to adjust both clearances between the rotor and pad so that they are equal and balanced. If only one side is adjusted it will cause braking failure.

1. Pads and pad holders are held in place by a 3 mm pad retainer bolt on the caliper. To remove the pads and pad holder, unscrew the retainer bolt, then gently push out the pads and holder. This may be easier to achieve by using an Allen wrench.
2. Once free of the caliper, the pads may be easily removed from the pad holder.

THE TEKTRON WARRANTY

Super73 brakes are from the Tektro brand. For any manufacturing problems or questions related to Tektro brakes, you can contact the local Tektro representative. The contact details of the distributors and places of services: <http://www.tektron.com/service-a.php?t=2>

BATTERY



The battery is the most important component of your Super73. Following a few simple rules, you can optimize its life:

- Never use third party or after market batteries on your bike!
- Do not use more than one battery at a time.
- Do not store a discharged battery. It could go into deep discharge which will reduce its life.
- Make it a habit to recharge at the end of each ride, so your bike will always be ready to go again.
- Even if it can withstand storage temperatures of 23°F - 104°F (-10°C - 40°C), you can optimize its shelf life by storing it at room temperature 65°-75°F (18° - 23°C).
- Observe operating conditions between 40°F - 85°F (4°C - 30°C).
- Do not leave your battery exposed to high temperatures or direct sunlight for long periods of time (for example, on the back of a car in direct sunlight).
- Please ensure that the contacts are always clean and do not insert metal objects.
- Do not dispose of the battery in your trash. There are proper disposal methods for lithium-ion batteries. Please check your local waste management regulations.



Do not open the battery. There is a risk of short circuit. Opening the battery will void the warranty. Protect the battery against mechanical damage, heat (in case of prolonged exposure to sunlight), fire, and immersion in water. There is a risk of explosion. In case of damage and improper use of the battery, vapors may emanate. Keep children away from the battery.



Please follow proper charging instructions before charging the battery found on pg. 12. To charge the battery, use only the original charger or charger approved by the manufacturer. Remove the battery from the charger and disconnect the charger from the power supply when charging is complete.

RANGE

The maximum range of a full charge depends on many variables such as: age of battery, type of terrain and incline, rider weight, speed, outside temperature, driving style, amount of pedaling, or tire pressure.

Range in cold weather:

- In case of extreme cold, the range of your electric bike is reduced. It is a normal physical process, and in no case a damage or defect of the battery. If you use your battery when temperatures rise, its energy will increase again.
- We advise you to store the battery and charge it at room temperature during cold days. The power consumption warms the battery and you benefit from a good battery life, even when it is cold outside.
- In winter, however, plan for shorter trips or pedal with a lower level of assistance.

Conditions that affect your battery's range:

- Temperature: Extreme cold and heat can affect the battery's capacity.
- Total Number of Charge Cycles: As the battery ages, total capacity can decrease.
- The battery has a total of 1,000 full cycles when it's new.
- Wind: Riding into a strong headwind can decrease range.
- Road Conditions: Excessively rough or hilly terrain requires the consumption of more power.
- Load: Carrying extra cargo on the bike or in a backpack will use more energy.
- Rider Weight: Please observe the max weight of 325 lbs (147kg).
- Repeated acceleration from a standing start.
- Poor Maintenance: Under-inflated tires, mal-adjusted brakes, a dry or dirty chain, can decrease range.

Tips for Maximizing Range:

- Charge the battery at a comfortable temperature range between 65°F - 75°F (18.3°C - 23.9°C)
- Lithium-ion batteries have no chemical memory, and it is not necessary to discharge the battery completely for the best performance. Charging a partially full battery will have no negative effect.
- Maintain proper tire pressure and lube the chain regularly.
- Operating temperatures between 40°F - 85°F (4°C - 30°C) will significantly increase range.



DANGER!

Never charge the battery in a flammable environment. For safety reasons, the charger and the battery must be placed on a dry, non-flammable surface.

Never charge or use a defective battery. Never send a battery by postal mail by yourself! A battery is in the category of hazardous/dangerous goods and requires certification to send by mail. Doing so without proper certification is punishable by law.

Immediately remove the battery from the Super73 if you notice damage to the electrical system and visit your local E-bike Specialist for inspection or contact Super73 directly. Any lack of professional expertise may cause damage or serious injury.

LIGHTING SYSTEM

The S2 model lighting system is wired into the main harness of the electric bike. For replacement, you must disconnect the cables on both the rear brake light and front light and get new parts. There are no batteries in the lights. Make sure the front and rear lights are clean before riding. If they are dusty, or dirty, clean them with a damp cloth for optimal visibility and safety.

SEAT

It is not possible to adjust the seat height of the Super73. It is fixed to the frame by bolts. The minimum seat clamping torque on the frame is 6.78 (Nm) 5lb / ft. For maintenance, use a cloth and water with a gentle soap for cleaning. Avoid leaving the seat in the sun too long, as the fabric can be damaged by the sun's UV rays. Avoid wearing clothes that may puncture or tear the seat.



The bike is subject to wear and tear, like all mechanical parts. Materials and parts react differently to wear and abrasion. If the intended life of a part is exceeded, it is possible that it will suddenly fail, which represents a certain danger for the rider. Any type of cracks, streaks, or color changes in highly stressed areas indicate the maximum wear of a part. It must, therefore, be replaced immediately. It is important to use genuine properly specified parts for safety-critical components during the replacement of worn parts.

SUSPENSION

Suspension components will require regular maintenance, cleaning, and greasing in order to keep the movement of these components fluid and in good working order. It is recommended to regularly inspect each component of the suspension for signs of wear.



Failure to maintain, check and properly adjust the suspension system may result in suspension malfunction, which may cause you to lose control and fall.

WARRANTY

I. Warranty.

Subject to the terms, conditions, and limitations herein, Super73 warrants to the original retail purchaser of the bike that (i) the frame, fork, and electronics of the bike will be free from defects in material and workmanship under normal use and service for one (1) year from the date of delivery, and (ii) the battery will be free from defects in material and workmanship under normal use and service for two (2) years from the date of delivery or 500 life cycles, whichever comes first (the "Limited Warranty"). The Limited Warranty exists for the abovementioned defects that were already present at the time of delivery of the bike and covers the battery, motor, controller, display and sensors. Like any rechargeable battery, your Super 73 rechargeable battery pack will experience a decrease in capacity over time as it is subjected to charge and discharge cycles. Super73 warrants that your battery pack will maintain 70% or higher capacity for at least 500 charge cycles or two years, whichever comes first. The battery warranty does not include damage from power surges, use of an improper charger, water damage, improper maintenance, or such other misuse or normal wear. This warranty is only valid for the first buyer. Any other remedy, such as compensation for damages of any kind or loss of use, is excluded. The warranty period cannot be extended by granting an additional warranty.

2. Remedies.

If the original retail purchaser notifies Super73, authorized dealer or the retail location from where the bike was purchased of a warranty claim within the applicable warranty period set forth above, Super73 will evaluate the warranty claim. The purchaser will be responsible for shipping the bike to the location notified by Super73. If Super73 determines that the defective part is covered by the Limited Warranty, Super73 will replace or repair the defective part, at Super73's sole discretion, without charge to the buyer and also reimburse the shipping cost incurred by the purchaser. If the defective part is not covered by the Limited Warranty, Super73 will repair or replace the defective part at the purchaser's cost and the purchaser will also be responsible for the shipping costs.

3. Requirements for this Limited Warranty to apply.

- (a) The original purchaser provides proof that the bike was purchased from Super73 or one of its authorized dealers or distributors.
- (b) The person seeking warranty coverage is the original and first owner of the bike (warranty is not transferable in the case of a re-sale).
- (c) The bike was used in accordance with its intended purpose. The Super73 bike is intended for use on paved roads.
- (d) The electronics including connectors and cables have not been repaired or modified.

For more information on warranty, remedies, requirements, exclusions, and limits please visit our website and contact us at support.super73.com