

ninebot one 

User Manual

Original Instructions

The manufacturer reserves the right to make changes to the One S2, release firmware updates, and update this manual at any time. Visit www.segway.com to download the latest user materials and watch the safety video. You must install the Ninebot App to follow the New Rider Tutorial, activate your One S2, and obtain the latest updates and safety instructions.

www.segway.com

EU201607-V1.0

— by —
SEGWAY

NOTE

You must have smart phone with Android system (version 4.3 or above) or with iOS system (version 7.0 or above), then download "Ninebot" App to initialize unit. The App will lead you through the New Rider Tutorial. For your safety, the vehicle will limit the max speed to 4 km/h before activation. After activation and before completing the New Rider Tutorial, the max speed will be limited to 7 km/h, For the first 1 km after completing the New Rider Tutorial, the max speed will be limited to 12 km/h, after which you can disable the speed limiter via the App and reach a maximum speed of 24 km/h.

Contents

1	Packing List	03
2	Diagram	04
3	Carry Mode	04
4	Charging	05
5	Battery Charge Level	05
6	Warning	06
7	First Use	09
8	Learning to Ride	10
9	Rider Safety	12
10	Additional Features	14
11	Maintenance	14
12	Removing the Battery	16
13	Specifications	18
14	Trademark and Legal Statement	19
15	Contact	20

Welcome!

Thank you for choosing the Ninebot One™ S2 by Segway (hereinafter referred to as One S2). Your One S2 is a portable smart electric self-balancing vehicle and leisure device.

Enjoy your ride!

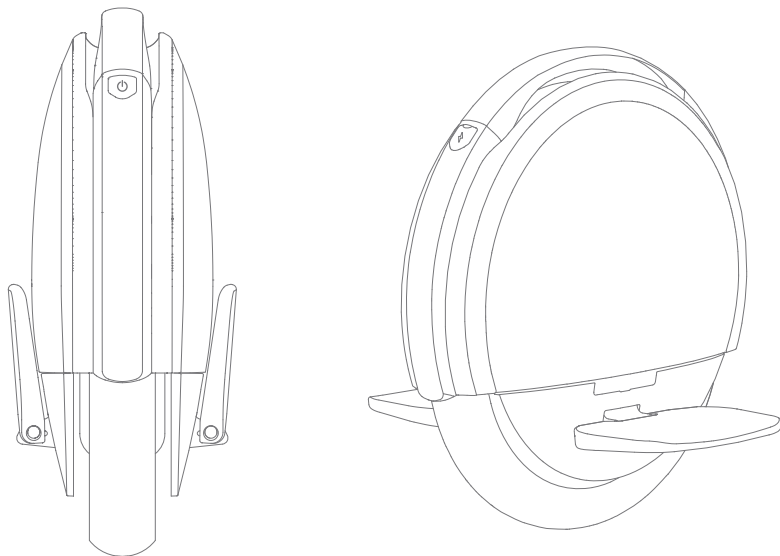

1 Packing List

Vehicle body

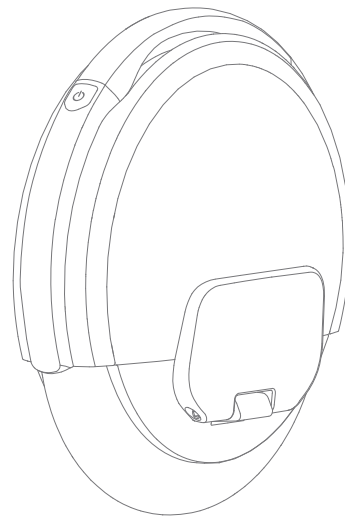

User Materials



Accessories

Charger, Power Cord

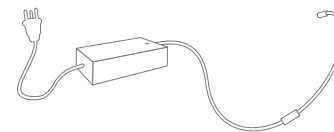

Valve Stem Extension



When unpacking your vehicle, please verify that the above items are included in the package. If you are missing any components, please contact your local dealer or retailer first.

Please retain the box and packaging materials in case you need to ship your One S2 in the future.

2 Diagram

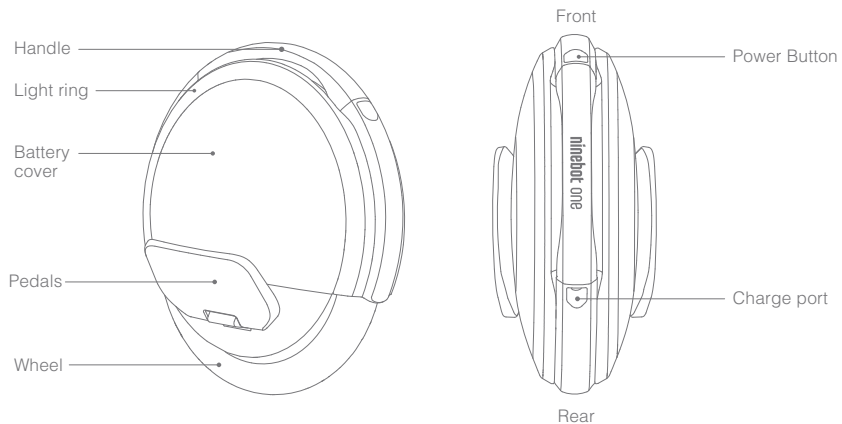

3 Carry Mode

Carry Mode prevents the wheel from spinning when you lift your vehicle by the handle while it is powered on. With Carry Mode you can step off your vehicle, carry it across or around obstacles, then put it down and continue riding — all without having to turn off your vehicle.

You can enable/disable Carry Mode in the App.

⚠ WARNING

Do not lift your vehicle by the handle when the vehicle is powered on when Carry Mode has been disabled. Doing so will cause the wheel to spin, and may result in personal injury or damage to your vehicle.

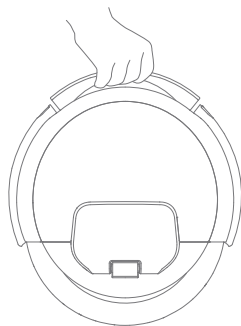

4 Charging

Turn off your vehicle before charging.

⚠ WARNING

Do not connect the charger if the charge port or charge cable is wet.

When charging, press the power button to enable a visual display of the charge level.

Your vehicle is fully charged when the LED on the charger changes from red (charging) to green (trickle charge).

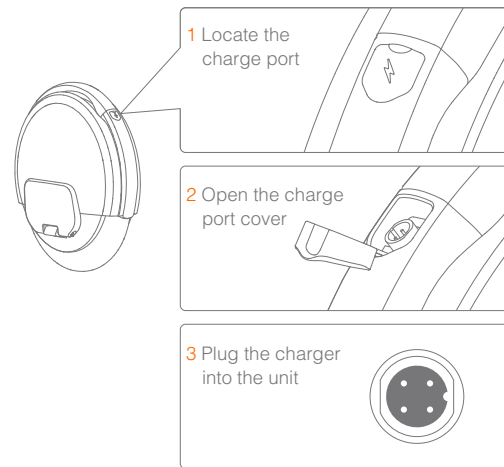

5 Battery Charge Level

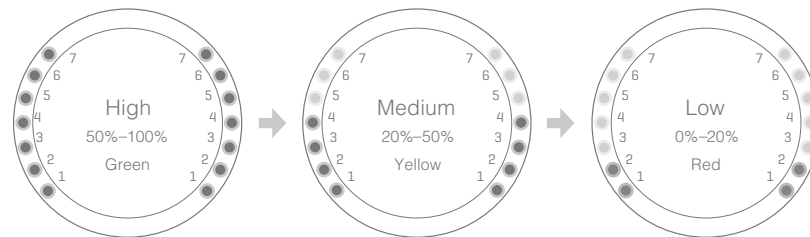

The battery charge level display appears when the vehicle is kept stationary.

Each pair of lights represents 14% of battery life. When the battery is nearly empty the lights blink in red. Use the App to read the remaining power and estimated remaining range.

As the power level decreases, your vehicle will gradually reduce the speed limit.

6 Warning

You must read and understand the Warnings and Rider Safety instructions in this manual before attempting to ride your One S2.

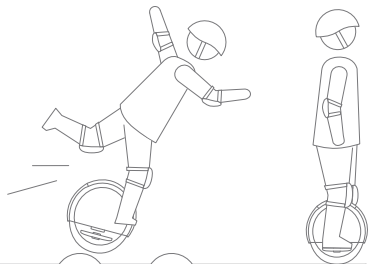

- ⚠ When traversing small bumps or uneven terrain, maintain a moderate speed — 3–10 km/h — and keep your knees bent. Do not go too slow or too fast; otherwise you may lose control and fall.

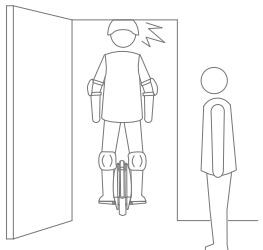

- ⚠ Watch your head when passing through doorways.

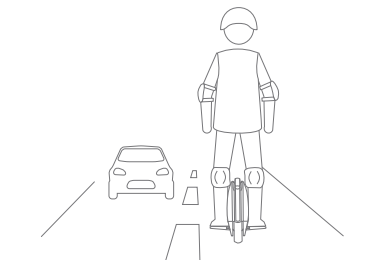

- ⚠ Do not ride on public roads, motorways, highways, or streets.

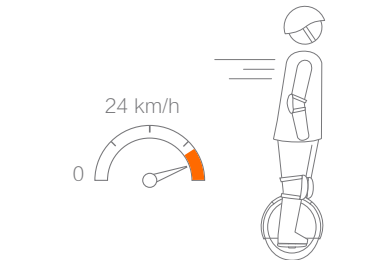

- ⚠ Do not accelerate when the vehicle tilts back or sounds an alarm. Do not attempt to override the speed limiter.

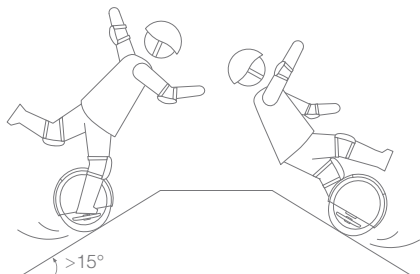

- ⚠ Avoid slopes steeper than 15° or you may lose traction.

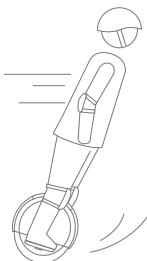

- ⚠ Do not accelerate or decelerate abruptly.

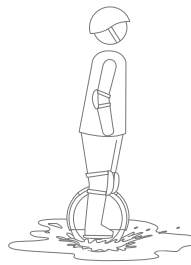

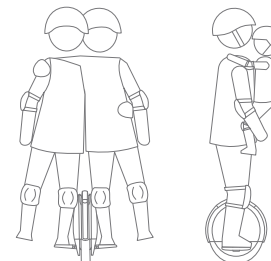

- ⚠ Do not ride through puddles or other bodies of water. Do not get wet.

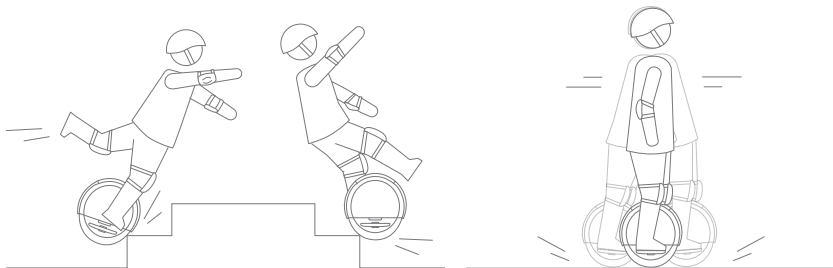

- ⚠ The One S2 is for one rider only. Do not ride double or carry any passengers. Do not carry a child.

Warning (cont'd)





 Do not ride over holes, curbs, steps, or other obstacles.

 Do not rock back and forth or shift your weight abruptly.



 Do not attempt stunts of any kind. Always keep both feet on the pedals.

 Maintain contact with the ground at all times. Do not jump or attempt stunts.

 Do not ride on limited traction surfaces.

7 First Use



Android



iOS

For your safety, your new vehicle is not activated at time of purchase, and the speed and sensitivity are set at low levels. You must install the App and follow the instructions to activate the vehicle before use.

You must have smart phone with Android system (version 4.3 or above) or with iOS system (version 7.0 or above), then go to the Apple App Store (iOS) or the Google Play Store (Android) and search for "Ninebot by Segway" to download and install the App. The App will lead you through the New Rider Tutorial.

 Scan to download the App.

1 Install the App and register/login.

2 Hold the vehicle upright and power it on. Turn it off and on again to familiarize yourself with the controls.

3 Click "Search Device" to connect to your vehicle. The vehicle will beep to indicate a successful connection.

4 Follow the instructions in the App.

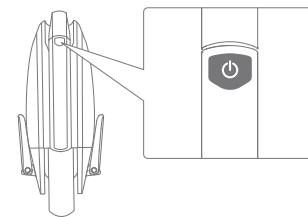
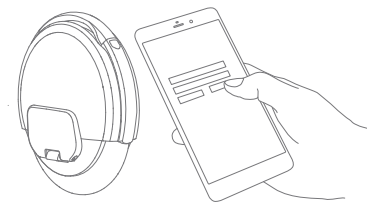

8 Learning to Ride



Wear an approved helmet and other protective gear to minimize any possible injury.

After activation, the App will lead you through the New Rider Tutorial. Please follow the instructions in the App and in this manual.

For your safety, the vehicle will limit the max speed to 4 km/h before activation. After activation and before completing the New Rider Tutorial, the max speed will be limited to 7 km/h. For the first 1 km after completing the New Rider Tutorial, the max speed will be limited to 12 km/h, after which you can disable the speed limit via the App.

Learning to ride proficiently can take many hours. Practice each step for 15 minutes each day until you are comfortable with that maneuver. Then move on to the next step and repeat the process.

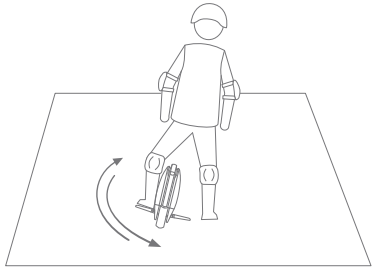

1 Get used to the way the vehicle operates: step on one pedal, then swing your leg back and forth to feel the controls.

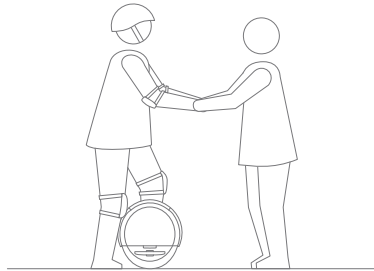

2 With assistance from a friend, put one foot on a pedal and gradually shift your body weight onto the vehicle.

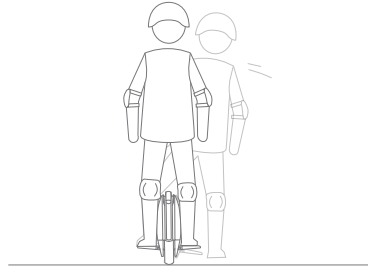

3 With assistance from a friend, place one foot on a pedal, raise the other off the ground for 1-2 seconds, and glide forward.

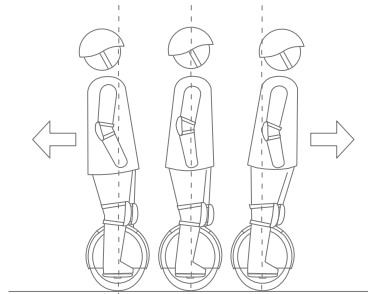

5 Place both feet on the pedals and practice traveling forward and backward by controlling your body's center of gravity.

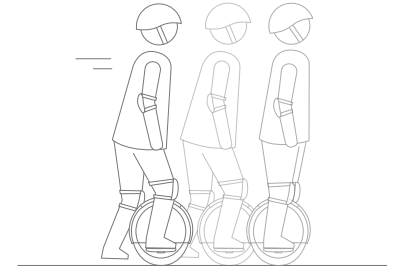

4 Place one foot on a pedal, push off with your other foot, and glide forward.

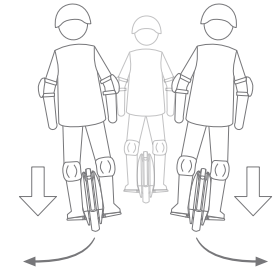

6 Turn by pressing harder on one pedal than the other, and by shifting your weight slightly.

9 Rider Safety

- The vehicle is an entertainment product, which is different from motor vehicles driving on the road. Before mastering riding skills, you need to practice. Neither Ninebot Inc. nor Segway Inc. is responsible for any injuries or damage caused by a rider's inexperience or failure to follow the instructions in this document.
- Please understand that you can reduce the risk by following all the instructions and warnings in this manual, but you cannot eliminate all the risks. Remember that whenever you ride the vehicle you risk injury or death from loss of control, collisions, and falls. When entering into public spaces always comply with the local laws and regulations. As with other vehicles, faster speeds require longer braking distance. Sudden braking on smooth surfaces could lead to wheel slip, loss of balance, or falls. Be cautious and always keep a safe distance between you and other people or vehicles when riding. Be alert and slow down when entering unfamiliar areas.
- Respect pedestrians by always yielding the right of way. Pass on the left whenever possible. When approaching a pedestrian from the front, stay to the right and slow down. Avoid startling pedestrians. When approaching from behind, announce yourself and slow down to walking speed when passing.
- In places without laws and regulations governing self-balancing electric vehicles, comply with the safety guidelines outlined in this manual. Neither Ninebot Inc. nor Segway Inc. is responsible for any property damage, personal injury/death, accidents, or legal disputes caused by violations of the safety instructions.
- Do not allow anyone to ride the vehicle on his/her own unless they have carefully read this manual, watched the safety video, and followed the New Rider Tutorial on the Ninebot by Segway App. The safety of new riders is your responsibility. Spot new riders until they are comfortable riding the vehicle. Make sure each new rider wears a helmet and other protective gear.
- Before each ride check for loose fasteners, damaged components, and low tire pressure. If the vehicle makes abnormal sounds or signals an alarm, immediately stop riding. Contact your dealer/distributor for service.
- Always wear a helmet when riding. Use an approved bicycle or skateboard helmet that fits properly with the chin strap in place, and provides protection for the back of your head.
- Be alert! Scan both far ahead and in front of your vehicle — your eyes are your best tool for safely avoiding obstacles and low traction surfaces (including, but not limited to, wet ground, loose sand, loose gravel, and ice).
- Do not attempt your first ride in any area where you might encounter children, pedestrians, pets, vehicles, bicycles, or other obstacles and potential hazards.
- Use caution when riding in new environments.
- To reduce risk of injury, you must read and follow all "CAUTION" and "WARNING" notices in this document. Do not ride at an unsafe speed. Under no circumstance should you ride on roads with motor vehicles. Always follow these safety instructions:
 - A) The following people should not ride Ninebot vehicle:
 - i. Anyone under 16 years old or above 50 years old. Riders between 16-18 years old should ride under adult supervision.
 - ii. Anyone under the influence of alcohol or drugs.
 - iii. Anyone who suffers from disease that puts them at risk if they engage in strenuous physical activity.
 - iv. Anyone who has problems with balance or with motor skills that would interfere with their ability to maintain balance.
 - B) Comply with local laws and regulations when riding this product. Do not ride where prohibited by local laws.
 - C) To ride safely, you must be able to clearly see what is in front of you and you must be clearly visible to others.
 - D) Do not ride in the snow, in the rain, or on roads which are wet, muddy, icy, or that are slippery for any reason. Do not ride over obstacles (sand, loose gravel, or sticks). Doing so could result in a loss of balance or traction and could cause a fall.
 - E) Do not accelerate or decelerate suddenly. Do not accelerate when the vehicle tilts back or sounds an alarm. Do not attempt to override the speed limiter.
 - F) While the Ninebot App is useful, do not allow the App to distract you while you are riding. Always pay attention to your surroundings.
- Never restart and ride your vehicle after it has indicated an empty battery condition or powered off due to low battery. Your vehicle may not have enough power to keep you balanced, especially if you demand a lot of power at once. If you restart and continue riding, you risk falling. Also, you risk damaging your batteries, resulting in reduced battery life and capacity.
- Do not insert the power cord if the charge port is wet.
- Use a surge protector when charging to help protect your vehicle from damage due to power surges and voltage spikes. Only use your Ninebot by Segway supplied charger. Do not use a charger from any other product.
- Always shut down your vehicle and unplug the AC Power Cord before performing any maintenance.
- Use only Ninebot by Segway approved parts and accessories. Do not modify your vehicle. Modifications to your vehicle could interfere with the operation of the vehicle, could result in serious injury and/or damage, and could void the Limited Warranty.

10 Additional Features

Lock Mode

Press the lock icon in the Ninebot App to enable Lock Mode when your One S2 is powered ON. If anyone tries to move your One S2 an alarm will sound.

Speed Limit Mode

Use the Ninebot App to enable Speed Limit Mode. When enabled, the maximum speed is set to a user-configurable level. The default speed limit is 7km/h.

Light Pattern

You can use the Ninebot App to change the pattern and colors of the lights on the sides of your One S2.

11 Maintenance

Cleaning

⚠ WARNING

Make sure the One S2 is powered OFF, the charge cable is unplugged, and the silicone cap on the charge port is tightly sealed before cleaning; otherwise you may expose yourself to electric shock or damage the electronic components. Do not wash your One S2 with a power washer or high pressure hose.

Wipe your One S2 clean with a soft, wet cloth. For stubborn stains, use a toothbrush and toothpaste. Scratches on plastic parts can be polished with extra fine grit abrasive paper.

NOTE

Do not wash your One S2 with alcohol, gasoline, acetone, or other corrosive/volatile solvents. These substances may damage the appearance and internal structure of your One S2.

Storing

Store the vehicle in a cool, dry place. Do not store it outdoors for extended periods of time. Exposure to excessive sunlight or temperature extremes (both hot and cold) may affect the vehicle's appearance, battery life, and tires.

Tire Pressure

Inflate tire to 35 psi.

Battery Maintenance

⚠ WARNING

Risk of fire. No user serviceable parts. Do not attempt to disassemble the battery.

Do not allow the battery to get colder than -4°F (-20°C) or hotter than 122°F (50°C), e.g. in a car. Do not expose the battery to fire. Do not discard or destroy the battery. For more information, refer to the label on the battery itself. Refer to your local laws and regulations regarding battery recycling and/or disposal.

To extend the battery's life, charge it frequently and avoid draining the battery completely. At 77°F (25°C) the battery range and performance is at its best; whereas at temperatures below 32°F (0°C) range and performance are decreased. Typically, at -4°F (-20°C) range can be half that of the same battery at room temperature. Battery range will recover when temperature rises. More details are available in the App.

NOTE

A fully-charged Ninebot One S2 can remain in standby mode for about 120 to 180 days. Completely draining the battery may cause permanent damage to the battery. Electronics inside the battery record the charge-discharge condition of the battery; damage caused by over-discharge or under-discharge will not be covered by the Limited Warranty.

12 Removing the Battery

⚠ WARNING

Removing a battery can be dangerous. You risk personal injury from electric shock. If you are not comfortable removing the battery yourself, please contact your dealer/distributor or email us.

The standard Ninebot One S2 (with a capacity of 310 Wh) has two batteries, one on either side. Removing one battery reduces the power, range, and weight of the Ninebot One S2. For your safety, the speed is limited when only one battery is installed. Please ride carefully.

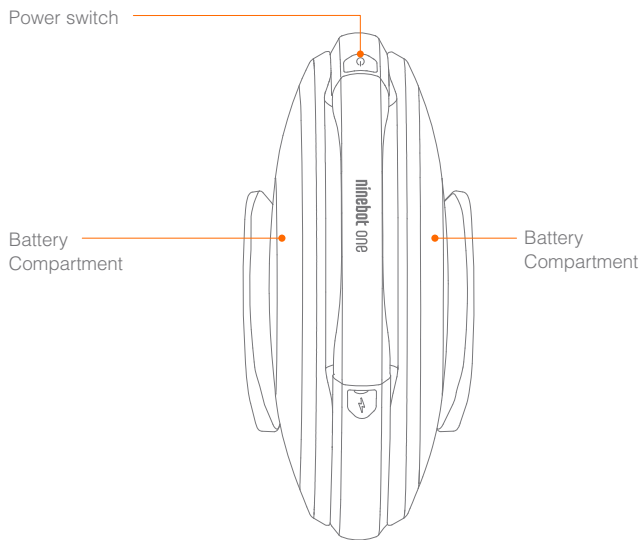

Install in the reverse order of removal.

① Remove the rubber plug

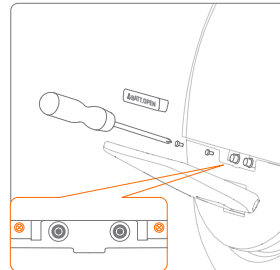

Power off the vehicle and disconnect the charger. Then remove the rubber plug on the side of the vehicle.

② Open the battery cover

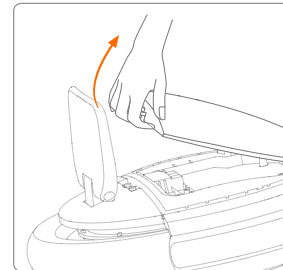

Use a Phillips-head screwdriver to remove the two screws. Then, with a firm tug, use your hand to lift and remove the battery cover.

③ Disconnect the wires

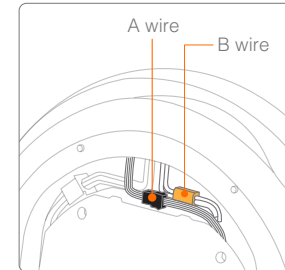

Unplug the black wire (A) first, then unplug the yellow wire (B). Pull the connector firmly. Do not pull on the wire itself or you may damage it.

④ Remove the screws

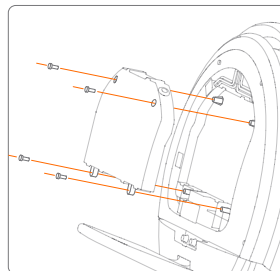

Use a Phillips-head screwdriver to remove the four battery screws as shown.

⑤ Install the battery cover

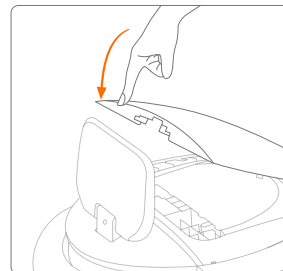

Press down firmly on the edges of the battery cover to snap it in place. Start at the top and work to the bottom. Be careful not to pinch any wires.

⑥ Install screws and plug

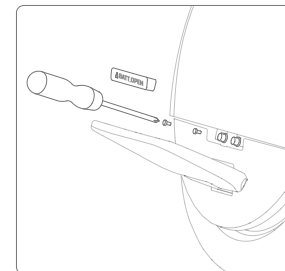

Use a Phillips-head screwdriver to install the battery cover screws, then press the rubber plug into place.

13 Specifications

	Item	One S2 Parameters
Dimensions	Vehicle Size	17.6 x 16.6 x 7.2 in (448 x 419 x 189 mm)
	Max. Payload	264 lbs (120 kg)
Weight	Net Weight	25 lbs (11.4 kg)
	Age	16–50 years
Rider Requirements	Height	4'0"–6'6" (120–200 cm)
	Max. Speed	14.9 mph (24 km/h)
Machine Parameters	Typical Range ¹	~18 miles (~30 km)
	Max. Slope	~15°
	Beginner Mode	Beginner mode is automatically deactivated after 0.6 miles (1 km) of riding. Enable beginner mode at any time via the App.
	Traversable Terrain	Pavement, packed dirt, slopes < 15°, obstacles < 1.2 inches (3 cm), gaps < 1.2 inches (3 cm).
	Operating Temperature	14–104°F (-10–40°C)
	Storage Temperature	-4–122°F (-20–50°C)
	IP Rating	IPX4
	Battery	Type
Nominal Voltage		54.3 VDC
Max. Charging Voltage		63 VDC
Charging Temperature		32–104°F (0–40°C)
Nominal Capacity		310 Wh
Motor	Battery Management System	Over-voltage, under-voltage, short circuit, and over-heating protection. Auto-sleep and auto-wake.
	Nominal Power	500 W
Display	Max. Power	1000 W
	Lighting	Ring type display panel on both sides, with 14x2 independent RGB LEDs, battery level display, and customized light patterns.

¹ Typical Range: tested while riding under full power, with 154 lbs (70 kg) load, at 77°F (25°C), and an average speed of 9.3 mph (15 km/h) on level pavement. Range varies with payload, environment, temperature, road conditions, and other variables.

Charger	Model Number	HT-A10-120W
	Manufacturer	Chingmi (Beijing) Technology Co., Ltd.
	Supplier	Chingmi (Beijing) Technology Co., Ltd.
	Nominal Power	120 W
	Input Voltage	100–240 VAC @ 50–60 Hz
	Output Voltage	Approx. 63
	Output Current	Approx. 1.9 A
	Charging Temperature	32–104°F (0–40°C)
	Charge Time	3 hours
Compliance	CCC,CB,CE,FCC,UL,PSE,KC,SAA	

14 Trademark and Legal Statement

Ninebot, ninebot one, ninebot in Chinese character(纳恩博) are trademarks of Ninebot; Segway, ninebot by segway are trademarks of Segway. Unless otherwise indicated or authorized by Ninebot or Segway, no user may change the Trademark. The forbidden changes include, without limitation, changes in the color, proportion, or design, or removal of any words, artwork, or trademark symbols. No part of the Trademark may in any form, alone or in combination with other marks, names, or products, or by any electronic, mechanical, photocopying, recording or any other means be used, or reproduced, or be broadcast, or transmitted without prior written permission from Ninebot.

iPhone and iOS, that of Apple Inc.; Android, that of Google Inc. The respective owners reserve the rights of their trademarks referred to in this manual. The vehicle is covered by U.S. and foreign patents. For patent information please go to <http://www.segway.com>. No entity or individual may exploit the patent without the authorization of the Ninebot.

This manual is prepared by Ninebot who reserves all its copyrights. Without prior written consent by Ninebot, any reproduction, modification, storage in a retrieval system or retransmission, or tied sale with other products in any form or by any means, regarding any part of the above products, service, information and materials, electronic, mechanical or otherwise, is illegal and strictly prohibited. Any infringement of our intellectual property will not be tolerated by Ninebot and Ninebot can seek injunction, relief and indemnifications available under the Trademark Law, Patent Law, Copy right Law and other relevant laws.

We have attempted to include descriptions and instructions for all the functions of the vehicle at the time of printing. However, your vehicle may differ slightly from the one shown in this document. Please note that there are multiple Ninebot by Segway models with different functions, and some of the functions mentioned herein may not be applicable to your unit. The manufacturer reserves the right to change the design and functionality of the vehicle product and documentation without prior notice.

All rights reserved. Copyright Ninebot 2016.

15 Contact

All products are delivered with a free of charge standard warranty that may vary depending on your region and product starting from the date of your purchase. Please make sure to keep your receipt to identify your purchase location and date. All after sales regulations shall be followed according to your region/local laws and regulations. You will find the latest standard warranty terms and conditions, certifications, contacts of local after service centers at our website www.segway.com. If you have any questions or inquiries, for quick and accurate respond, please prepare your Serial Number (which you can find on the package and your product with format of e.g. "A1BCD2345E0000") and your receipt of purchase before contacting your local after service center. In case you need further assistance claiming warranty, please do not hesitate to contact us

1. Local dealer or retailer

Please consult your unit with prove of delivery, receipt or order confirmation to your local dealer or retailer.

You can also check www.segway.com for local official distributor contacts.

2. EMEA: Segway Europe BV.

Hogehilweg 8 ,1101 CC Amsterdam ,The Netherlands

E-mail: service@segway.eu.com

3. APAC: Ninebot Inc.

1F A1 BLDG., ZGC DongSheng Science Park(Northern Territory), 66 Xixiaokou Rd. Haidian Disct. Beijing, China

Tel: +86-10-84828002 (Consultation) 400-607-0001 (After-sales service)

E-mail: sales@ninebot.com (Consultation) service@ninebot.com (After-sales service)

⚠ Warning

Product warranty shall be followed and regulated base on the local region laws and regulations.

Warranty shall start from the purchasing date with valid invoice and stamped warranty sheet.

Unit with activation requirement needs to be properly activated before the warranty claim.

Website



Facebook



WeChat



Affix barcode here.