

OWNER'S MANUAL

WELCOME TO THE ULTIMATE
RIDING EXPERIENCE

ONEWHEEL+
ONEWHEEL+^{XP}

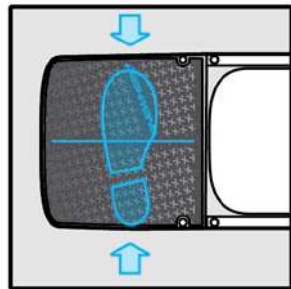

- Switch on Onewheel+ using power switch on the side.
- Step fully and firmly on both sides of the blue dividing line.



- Always wear a helmet.
- Lean on a friend to get started.
- Slowly come up to balance.

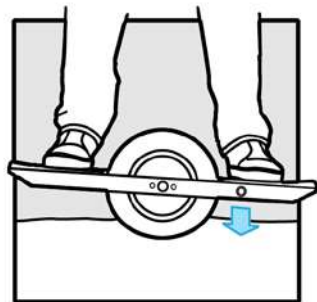

- Onewheel+ will engage when you reach a horizontal orientation.
- Lean forward to accelerate.
- Lean back to slow down.
- Lean side to side to turn.

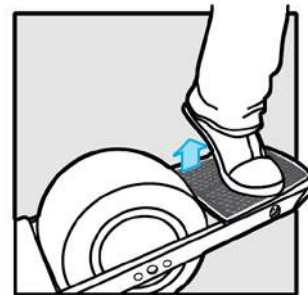

- **Slow down to < 1 mph** and with your toe planted, lift your heel from one side of the rider detection area.
- You can also jump off with both feet, but **never remove only one foot.**

WELCOME TO THE REVOLUTION!

Now that you're a proud owner of your very own Onewheel+ we want to keep you safe while you experience a whole new way of riding. We've created this owner's manual to share important safety, performance and service information with you. Please read it before you take your first ride and keep it for reference.

GETTING THERE IS MORE THAN HALF THE FUN!

IN THIS MANUAL ONEWHEEL+ REFERS TO BOTH ONEWHEEL+ AND ONEWHEEL+ XR, UNLESS OTHERWISE NOTED.

SAFETY OVERVIEW

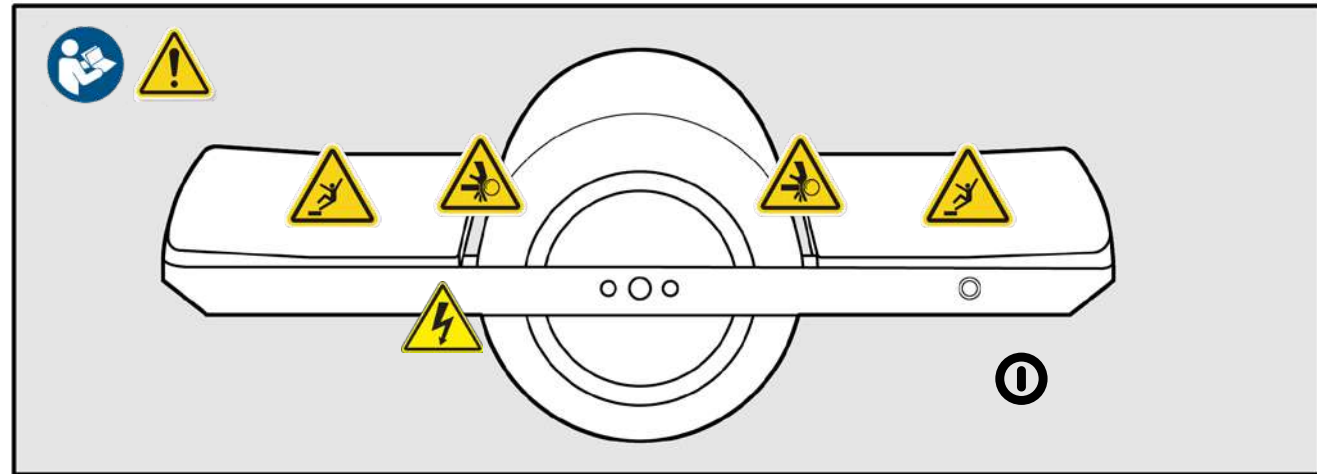

WARNING

RISK OF DEATH OR SERIOUS INJURY

Whenever you ride Onewheel+, you risk death or serious injury from loss of control, collisions and falls. To ride safely, you must read and follow all instructions and warnings in the User Manual.

GENERAL WARNINGS

Like any sport, Onewheeling involves risk of injury. By choosing to ride a Onewheel+, you assume the responsibility for that risk. It's important that you understand and practice the rules of safe and responsible riding and proper use and maintenance to reduce the risk of injury. This manual contains many **"WARNINGS"** and **"CAUTIONS"** concerning the consequences of failing to follow safe riding practices and properly maintain and inspect your Onewheel+.

Because it's impossible to anticipate every situation or condition that can occur while riding your Onewheel+, this manual makes no claim to represent the safe use of Onewheel+ under all conditions. There are risks associated with the use of any boardsport that cannot be predicted or avoided, and those are the sole responsibility of the rider.

The word  **WARNING** indicates a potentially hazardous situation that, if not avoided, could result in serious injury or death.

The word  **CAUTION** indicates a potentially hazardous situation or unsafe practice that, if not avoided, could result in minor or moderate injury, serious damage to your Onewheel+ and the voiding of your warranty.

The word  **TIPS** indicates information to help you get the most out of your Onewheel+ experience.

REGISTER YOUR ONEWHEEL+

Congratulations on the purchase of your new Onewheel+.

Register your Onewheel+ today.

Please visit <https://onewheel.com/pages/register>

WE CAN NOT GUARANTEE A WARRANTY CLAIM UNLESS YOUR BOARD IS REGISTERED.



- **MAXIMUM RIDER WEIGHT: 275 lb / 125 kg.**
- **DO NOT ALLOW CHILDREN UNDER THE AGE OF 14 TO USE THIS PRODUCT.**
- **ADULT SUPERVISION IS REQUIRED.**

SPECIAL NOTE TO PARENTS AND GUARDIANS

As a parent or guardian, you are responsible for the activities and safety of your minor or child (while he or she is operating a OneWheel). Please ensure that their OneWheel+ is in good repair and safe operating condition and that your child understands its proper use. It is also important that both you and your child learn, understand, and obey all applicable local motor vehicle and traffic laws. Always make sure your child is wearing proper protective equipment, including a helmet and wrist guards. **ONEWHEEL+ IS NOT RECOMMENDED FOR CHILDREN UNDER THE AGE OF 14. FOR CHILDREN 14 YEARS OF AGE AND OLDER, ADULT SUPERVISION IS REQUIRED.**

DOWNLOAD OUR APP

Sync to your board from the Onewheel app to customize your riding experience with Digital Shaping™. The Onewheel app also allows you to check your battery status for epic adventures, toggle your LED lights for night cruising and track riding data.

✓ **TIP:** Search “Onewheel” on Google Play or Apple App Store.



HOME SCREEN

Your dashboard. Select your shaping, monitor your board and see live stats.

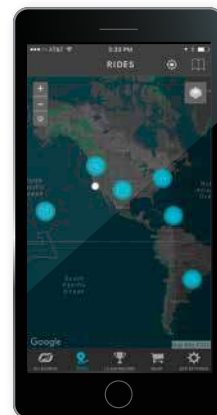

RIDES SCREEN

See posted rides from all over the world on phone or browser.

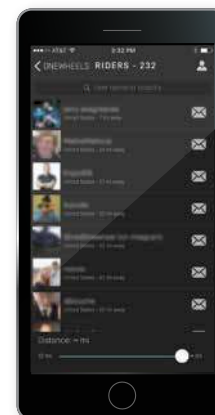

RIDERS NEAR BY

Join the community and connect with other Onewheel riders.



LEADERBOARD

See top stats and mileage.

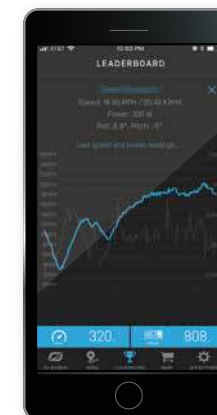

RIDE DETAILS

See stat details from top rides.

DIGITAL SHAPING 2.0

Sync to your board from the Onewheel app to customize your riding experience. Digital Shaping 2.0 provides the pinnacle of performance, comfort and control. Inspired by surfboard shapers creating different boards for different rides, Digital Shaping 2.0 offers a complete quiver of Shapings selectable from your smartphone.



DIGITAL SHAPING
2.0

Select your ride mode/shaping



Open shaping descriptions

SHAPINGS / RIDE MODES

 <p>MAX SPEED 12 MPH</p> <p>SEQUOIA Chill. You're in Sequoia. Mellow, controlled and approachable, Sequoia is the perfect "take it easy" shaping.</p> <p>Playful Aggressive</p> <p>Town Trail</p>	 <p>MAX SPEED 15 MPH</p> <p>CRUZ The Goldilocks of shapings, Cruz is not too tight and not too loose. An honest ride feel with plenty of power for the bumps in the road, Cruz has you covered.</p> <p>Playful Aggressive</p> <p>Town Trail</p>	 <p>MAX SPEED 19 MPH</p> <p>MISSION Loose, fluid and buttery, Mission is a homage to those knee-deep powder days. Pairs nicely with smooth pavement.</p> <p>Playful Aggressive</p> <p>Town Trail</p>	 <p>MAX SPEED 19 MPH</p> <p>ELEVATED Elevate the nose for maximum hill climbing and park riding.</p> <p>Playful Aggressive</p> <p>Town Trail</p>	 <p>MAX SPEED 20 MPH</p> <p>DELIRIUM Turn it up to Eleven. Raw, aggressive and hyper-responsive, Delirium rides with intensity and eats single-track for breakfast.</p> <p>Playful Aggressive</p> <p>Town Trail</p>
--	--	---	---	--

ONEWHEEL+

HYPERCORE

Hypercore™ provides incredibly smooth power and torque enabling you to climb over anything.

DIGITAL SHAPING 2.0

Smoother? More aggressive? Select different ride modes from your smartphone with the Onewheel App.

SURESTANCE

Pure footpad bliss. A perfect fit and ultimate control no matter the width of your stance is.

5-7mi
RANGE

25lbs
WEIGHT

30min*
RE-CHARGE

*CHARGE TIME ESTIMATED STARTING FROM A 10%-90% CHARGE.



ONEWHEEL+ XR

HYPERCORE

Hypercore™ provides incredibly smooth power and torque enabling you to climb over anything.

DIGITAL SHAPING 2.0

Smoother? More aggressive? Select different ride modes from your smartphone with the Onewheel App.

SURESTANCE

Pure footpad bliss. A perfect fit and ultimate control no matter the width of your stance is.

12-18mi
RANGE

27lbs
WEIGHT

100min*
RE-CHARGE

*CHARGE TIME ESTIMATED STARTING FROM A 10%-90% CHARGE.



TABLE OF CONTENTS

00

WELCOME

WELCOME TO THE REVOLUTION	03
SAFETY OVERVIEW	04
GENERAL WARNING	06
REGISTER YOUR ONEWHEEL+	07
SPECIAL NOTE TO GUARDIANS	09
DOWNLOAD OUR APP	10
01 PUT SAFETY FIRST	18

02 RIDING YOUR ONEWHEEL+	20
Basic balance	22
Regenerative braking	24
Understanding the footpad	24
Direction and speed	25
Turning	25
Ways to dismount	26
Push back	28
03 MAINTAINING YOUR ONEWHEEL+	36
End blocks	37
Footpads	37
Tire	38
Battery	39
Battery charger	40
How to charge your battery	40

04 GETTING TO KNOW YOUR ONEWHEEL+	42
Main power pushbutton switch	43
Status indicator	44
Decoding your Onewheel+	45
General board care	46
05 MORE WAYS TO RIDE SAFELY	48
Onewheel+ specifications	56
Ultracharger specifications	56
Onewheel+ XR specifications	57
XR charger specifications	57
Warranty	58
Declarations of Conformity	63
Contact	66

PUT SAFETY FIRST

01

RIDE SAFELY

Whether you're a pro or brand new to boardsports, it's always important to ride safely. Here are a few tips to ensure that you and your Onewheel+ stay in one piece.

HELMET

Always wear an ASTM F1492-08, CPSC and/or CE EN1078 certified helmet when riding your Onewheel+. Be sure to attach the chin strap and follow the helmet manufacturer's instructions for fit, use and general care.

OTHER SAFETY EQUIPMENT

It's a good idea to wear wrist guards, elbow pads and kneepads for extra protection.

SHOES

Always wear shoes that will stay on your feet and grip the board. Never ride barefoot or in flip-flops.

SEE SECTION 05 "MORE WAYS TO RIDE SAFELY" FOR MORE SAFETY INFORMATION.

⚠ WARNING: Many local governments legislate "road worthy" laws and require specific safety equipment. It is your responsibility to familiarize and comply with all applicable laws of the location where you ride your Onewheel+. This includes properly equipping yourself and your Onewheel+ as required by law.



RIDING YOUR ONEWHEEL+

02

AN INCREDIBLE RIDE

Quite simply the most beautiful riding experience on the planet. Snowboard all year, hack your commute, dominate terrain, and try to wipe that grin off your face. So easy grandpa can do it, so fun the pros can't get enough of it.

Onewheel+ is designed to be intuitive. Anyone can learn the basics in just a few minutes. Once you start riding regularly, there's plenty of room to challenge yourself.

BEFORE YOU GET ON YOUR ONEWHEEL+

- Always do a safety check before each ride.
- Read all safety instructions.
- Wear a helmet and other protective gear.

Choose a safe, controlled and calm environment away from cars, crowds, obstacles and other potential hazards.

BASIC BALANCE

Remember, Onewheel+ is self-balancing so there's no need to muscle your way onto the board. Instead, use slow, small movements.

When Onewheel+ is on the ground, you'll notice a lower side and a higher side. Always step onto the lower side first. Then place your other foot onto the rider-detection area. Keep your legs straight (like you are standing on the ground) with a very slight bend in your knees.

Stand up slowly and Onewheel+ will engage.

- ✓ **TIP:** Have a friend's shoulders handy to help you the first few times you get on your Onewheel+. After practicing a few times, we promise you'll be a pro.
- ✓ **TIP:** Look where you want to go (don't look down).
- ✓ **TIP:** Use light, constant pressure to control your Onewheel+.
- ✓ **TIP:** Don't bend your knees, rather stand tall on your first rides.

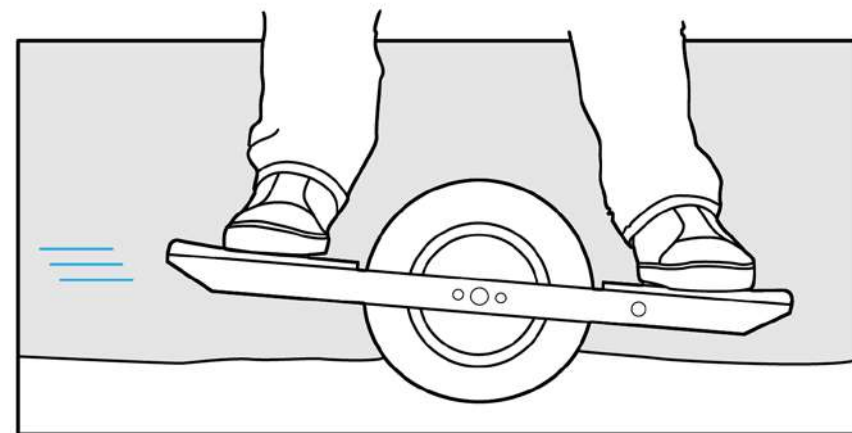
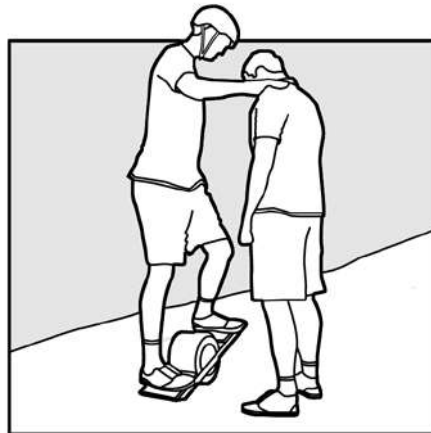

REGENERATIVE BRAKING

Decelerating while going downhill recharges the Onewheel+ battery.

⚠ WARNING: Riding hills exceeding a 15% grade is extremely dangerous and may result in loss of control or damage to your Onewheel+.

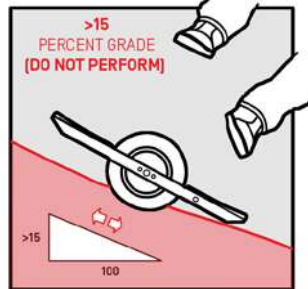
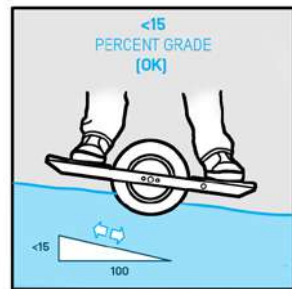

UNDERSTANDING THE FOOTPAD

The front footpad is pressure sensitive and divided into two zones, one on each side of the central line. Both zones must be pressed to begin riding. To stop, slow to a standstill and then remove your foot from one/both zones.

✓ **TIP:** Avoid repositioning your foot while riding.

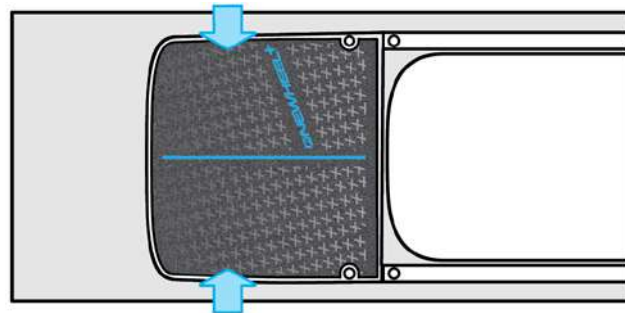

DIRECTION AND SPEED

Lean forward to move forward, and lean back to slow down or to move backwards. The more you lean, the faster you'll go.

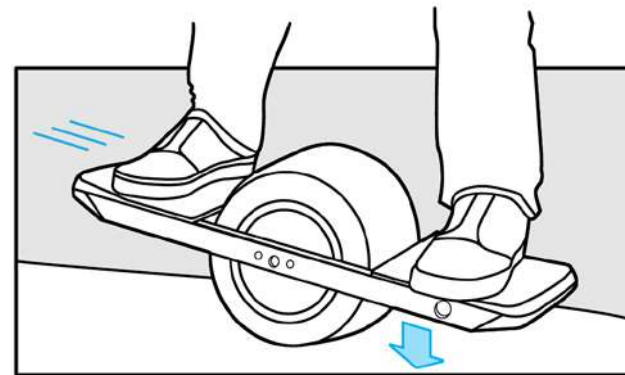

TURNING

Use subtle heel-toe pressure for turning left or right. You will begin to turn in the direction you lean. The more you lean, the sharper the turn.

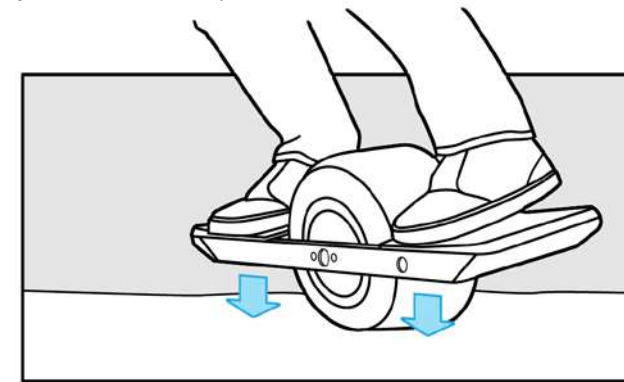

RANGE

Range varies on an assortment of factors including rider weight and riding style, terrain, inclines and declines and tire pressure. For optimal range, we recommend the following tips:

- ✓ **TIP:** Fully charge your Onewheel+.
- ✓ **TIP:** Ensure the tire pressure is at 20psi.*

*Tire pressure makes a significant difference to Onewheel range, top speed and ride quality. Even a few PSI change can alter the ride

WAYS TO DISMOUNT

When you're done riding, slow down to a standstill by leaning backward to decelerate. Then either lift your heel while maintaining balance or jump off with both feet.

- ✓ **TIP:** Both rider-detection areas must be pressed to start riding. If you slow down and remove your foot from only one area, the Onewheel+ will disengage.
- ⚠ **WARNING:** Never step off with your back foot first [the foot not on the rider-detection area]. This increases risk of a fall and possible injury.

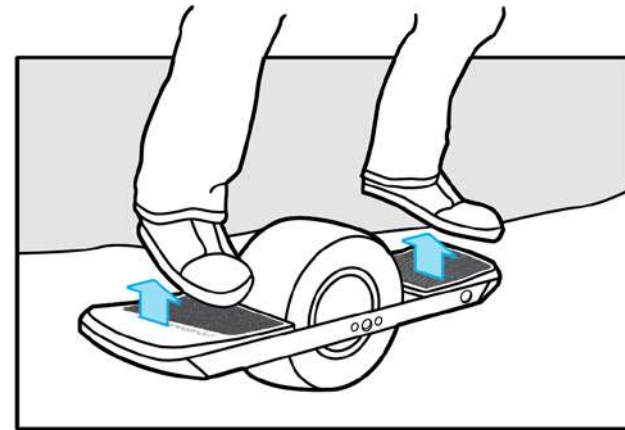
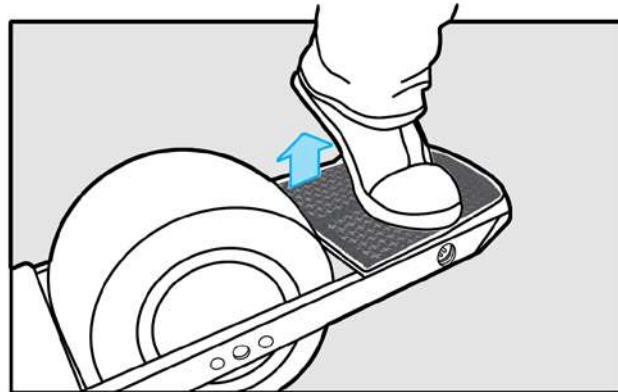

PUSH BACK

Like everything in life, Onewheel+ has its limits. If at any time you attempt to go too fast, descend a very steep hill or ride with a low battery, your Onewheel+ will “push back.” In a push-back situation, the nose of the board will lift to slow the rider down. The only way to avoid push back is to decrease your speed by leaning back. If you’d like to go a bit faster, you can switch your Digital Shaping to a more aggressive setting. This will have a higher threshold for push back.

⚠ WARNING: Ignoring safety warnings, including push back, may result in loss of control, serious injury or death.

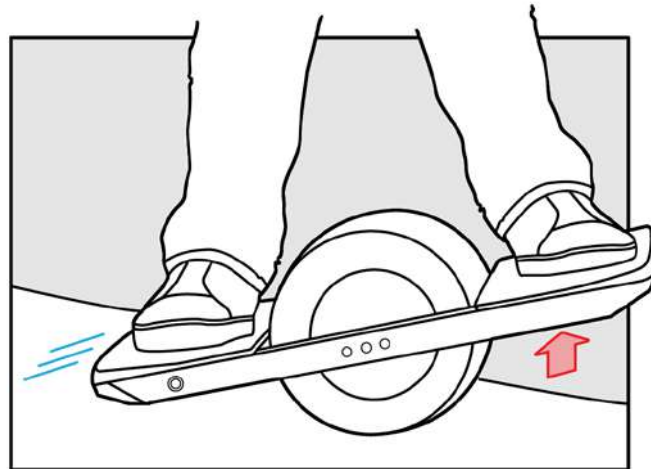

FULL-BATTERY PUSH BACK

When the battery is fully charged and you continue to charge it through regenerative braking (e.g., traveling downhill), you may experience “Full-Battery Push Back.” This is to prevent overcharging the battery cells. If this happens, simply switch your Onewheel+ OFF and ON again, and travel up the hill for a few moments to expend some of the charge. You will now be able to continue riding downhill.

⚠ WARNING: Never attempt to ride down a long or steep hill with a freshly charged Onewheel+. Loss of control or damage to your Onewheel+ may occur.

LOW-BATTERY PUSH BACK

When your Onewheel+ battery is extremely low, it will perform a much more aggressive push back and will become inoperative. This means a full battery charge is needed.

⚠ WARNING: Continuing to ride when low-battery push back occurs may result in sudden shutdown or damage to your Onewheel+.

SPEED PUSH BACK - DO THIS!

Push back is an important safety feature. Ignoring or trying to push through push back is extremely dangerous.

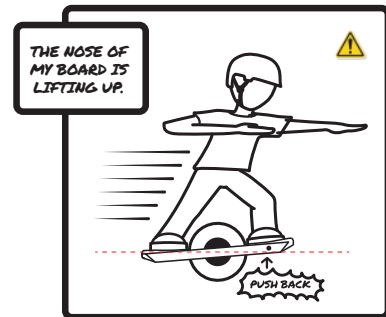

⚠ CAUTION: PUSH BACK

The nose of the board lifts up to warn the rider to slow down.

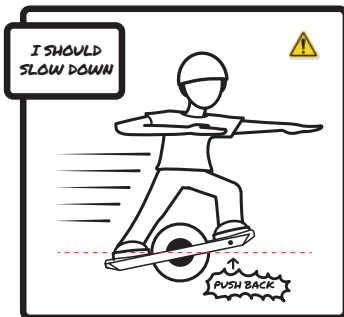

⚠ CAUTION: PUSH BACK

The rider recognizes push back and plans to adjust.

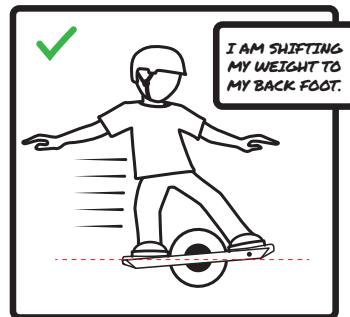

Rider shifts weight to the back foot in order to slow down.

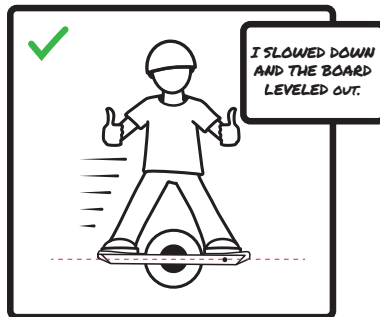

Rider has slowed down and the board returns to riding normally.

SPEED PUSH BACK - NEVER DO THIS!

Push back is an important safety feature. Ignoring or trying to push through push back is extremely dangerous.

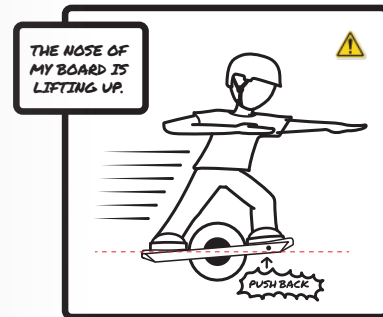

⚠ CAUTION: PUSH BACK

The nose of the board lifts up to warn the rider to slow down.

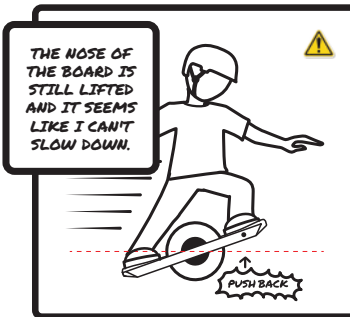

⚠ WARNING: DO NOT IGNORE PUSH BACK

If the rider's weight continues to be forward the board will continue to give the rider push back.

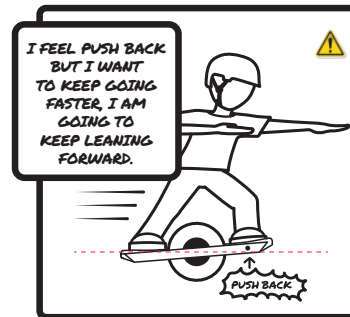

⚠ WARNING: DO NOT IGNORE PUSH BACK

Rider leans weight forward to accelerate. Board continues to try to push rider back.

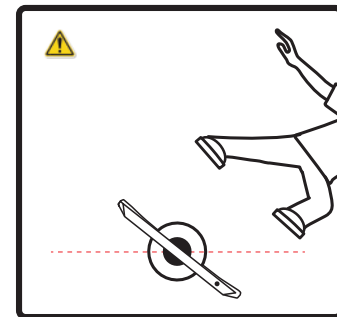

⚠ WARNING: DO NOT IGNORE PUSH BACK

Ignoring safety warnings, including push back, may result in loss of control, serious injury or death.

FULL BATTERY PUSH BACK - DO THIS!

Push back is an important safety feature. Ignoring or trying to push through push back is extremely dangerous.

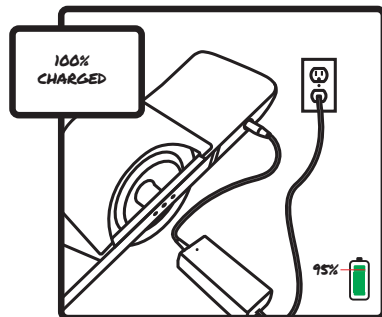

Onewheel is 100% charged.

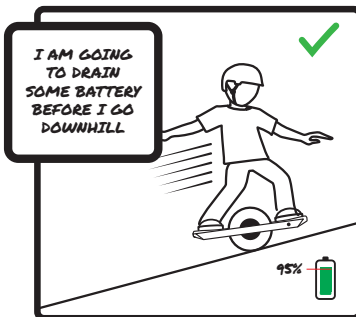

⚠ CAUTION: PUSH BACK
Ride uphill until the battery is below 95% charged.

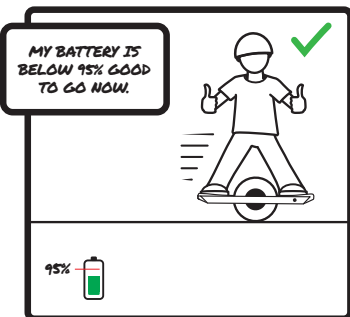

After draining the battery under a 95% charge, the battery is ready for regenerative braking.

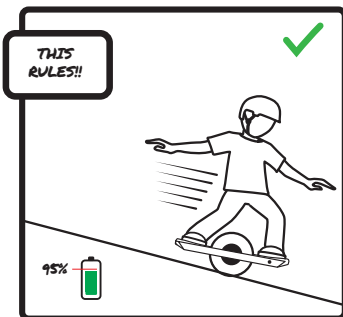

Good to go, have fun.

FULL BATTERY PUSH BACK - NEVER DO THIS!

Push back is an important safety feature. Ignoring or trying to push through push back is extremely dangerous.

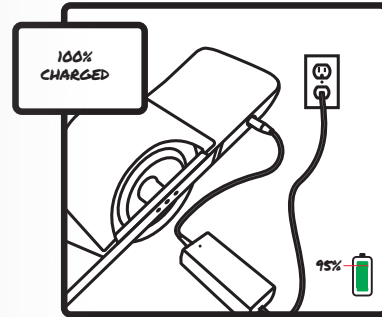

Onewheel is 100% charged.

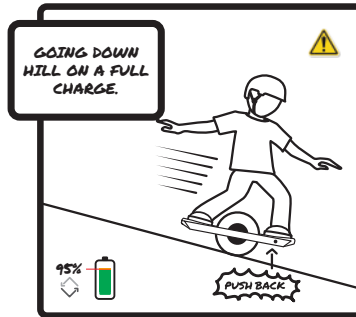

⚠ WARNING: DO NOT IGNORE PUSH BACK
The nose of the board lifts up to warn the rider the battery can't handle any more regen braking.

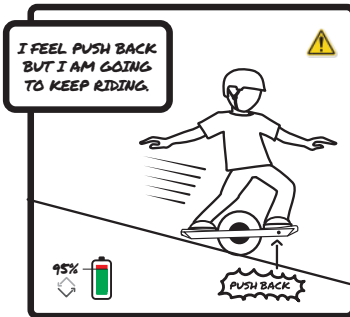

⚠ WARNING: DO NOT IGNORE PUSH BACK
If regenerative braking continues the board will continue to push back.

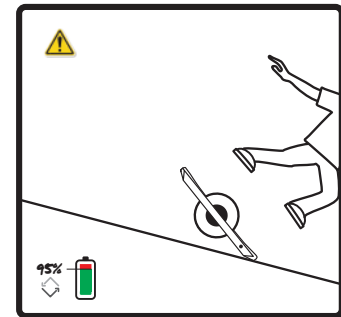

⚠ WARNING: DO NOT IGNORE PUSH BACK
Ignoring safety warnings, including push back, may result in loss of control, serious injury or death.



MAINTAINING YOUR ONEWHEEL+

03

SAFETY CHECK

Doing regular safety checks will help prolong the life of your Onewheel+. We recommend that you carefully inspect your Onewheel+ before every ride to make sure that there are no loose, damaged or unusually worn parts. All nuts and bolts should be tight. Most Onewheel+ components were designed so that they can be easily replaced if there is a problem.

CONTACT ONEWHEEL CUSTOMER SERVICE IF YOU HAVE QUESTIONS. EMAIL SUPPORT@ONEWHEEL.COM

- ⚠️ **WARNING:** Before performing any minor work on your Onewheel+, make sure the power switch is in the “OFF” position.
- ⚠️ **WARNING:** The footpads are an integral part of the safety system for the Onewheel+. Never ride with damaged wood or grip tape, and never attempt to replace grip tape. Replacement footpads are available at www.onewheel.com.
- ⚠️ **CAUTION:** Riding a damaged Onewheel+ will void its warranty.

END BLOCKS

End blocks are designed as wear-and-tear components and must be replaced as they wear. More details can be found at <https://onewheel.com/support>

FOOTPADS

Inspect footpads for any cracks, punctures or tears in the grip tape, particularly in the rider-detection area. If you notice any damage, contact support@onewheel.com for replacement parts.

- ⚠️ **CAUTION:** Never attempt to remove or replace grip tape with aftermarket grip tape.
- ⚠️ **WARNING:** Riding with a damaged footpad is extremely dangerous. Replace immediately.

TIRE

Check your Onewheel+ tire for any cuts in the tread and sidewall. Also be sure it is sufficiently inflated, up to 20 PSI. The best way to check and inflate your Onewheel+ tire is with a quality digital gauge and compressor at your local gas station. If your tire is damaged or has a hole, please visit our website for more information: <https://onewheel.com/support>

- ⚠️ **WARNING:** Exceeding the recommended maximum pressure of 20 PSI [1.4 bar] could damage your Onewheel+ and result in injury. It will also void your warranty.
- ⚠️ **CAUTION:** Riding Onewheel+ with a flat or under-inflated tire will void your warranty.
- ⚠️ **CAUTION:** Pencil-type automotive tire gauges can be inaccurate. Always use a quality digital gauge.

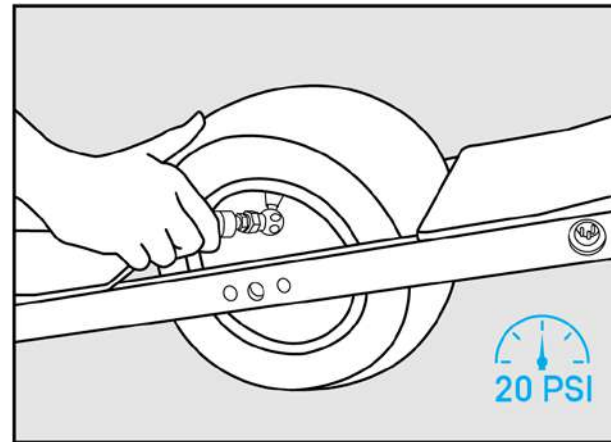

BATTERY

Be careful not to overcharge or undercharge your battery. The battery should be charged at least once every two months. Failure to do so may void your warranty. You must dispose lithium batteries according to local laws and regulations.

- ⚠️ **WARNING:** If the battery pack appears to be damaged or is not holding a charge, please don't use it. For further assistance, contact Onewheel+ customer support at 1-800-283-7943 or send an email to support@onewheel.com
- ⚠️ **CAUTION:** Do not expose the battery to extreme high or low temperatures. These may degrade or damage the battery pack.

BATTERY CHARGER

Use only the provided Ultracharger (model FY5803500) to charge your Onewheel+, or the FY6303200 charger for your Onewheel+ XR.

NOTE: The FY5803500 and FY6303200 chargers can operate on 110V-240V. Depending on your country, a plug adapter may be required.

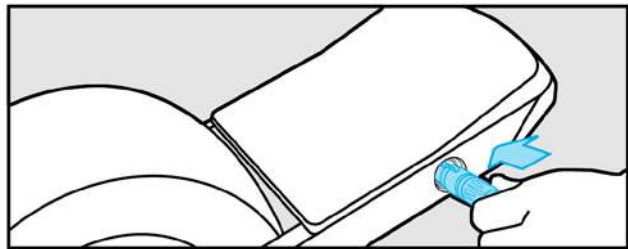

HOW TO CHARGE YOUR BATTERY

- 01** Connect the charger to an “AC” supply and then to the Onewheel+ charging port. The charger will display a red light.
- 02** A green light will appear when the battery pack is fully charged, and the charger will automatically stop charging.
- 03** Disconnect the charger by pressing the release button on the charging plug and pulling firmly.

✓ **TIP:** Periodically leave the charger attached to your Onewheel+ overnight to allow the battery pack to thoroughly balance.

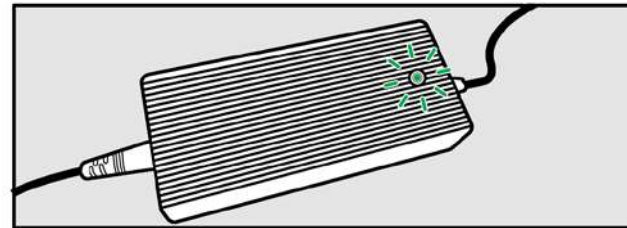
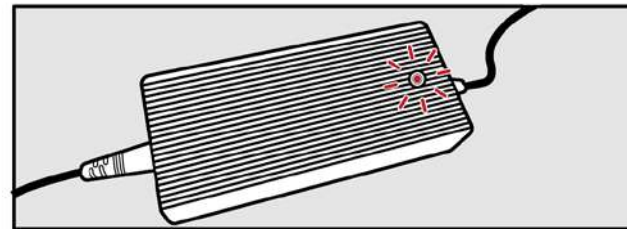

⚠ **CAUTION:** Only use the FY5803500 charger to charge your Onewheel+, or the FY6303200 to charge your Onewheel+ XR. Use of any other charger will void your warranty and may damage your Onewheel+.

⚠ **CAUTION:** All electronic and drive components may only be repaired by Future Motion or by a Onewheel+ authorized service center. Any other adjustments will void your warranty.

⚠ **CAUTION:** Don't begin any repairs or adjustments on your Onewheel+ until you properly understand how to complete them. An improper adjustment or repair may result in damage to your Onewheel+ or a potentially serious injury. A qualified Onewheel+ mechanic should perform complex services, maintenance and repairs in a properly equipped facility.

GETTING TO KNOW YOUR ONEWHEEL+

04

UNDERSTANDING THE AWESOME

You already know Onewheel+ is super fun, but it's also important to your safety, performance and enjoyment to understand how Onewheel+ works. If after reading this manual you still have questions, please contact Onewheel+ customer support at 1-800-283-7943 or send an email to support@onewheel.com

MAIN POWER PUSHBUTTON SWITCH

Onewheel+ is powered ON and OFF by the pushbutton switch on the side of the Onewheel+. Always make sure your Onewheel+ is on the ground in the ready-to-ride position before switching it "ON." Always turn your Onewheel+ "OFF" when charging, storing or carrying it.

- ⚠ **WARNING:** Never pick up your Onewheel+ when the switch is in the "ON" position since the wheel may spin, thus causing a safety hazard.
- ⚠ **CAUTION:** Do not press the rider-detection area section of the footpad while powering on your Onewheel+ or it will not operate.

- ✓ **TIP:** Turning on your Onewheel+ while it is not on the ground will cause an error.

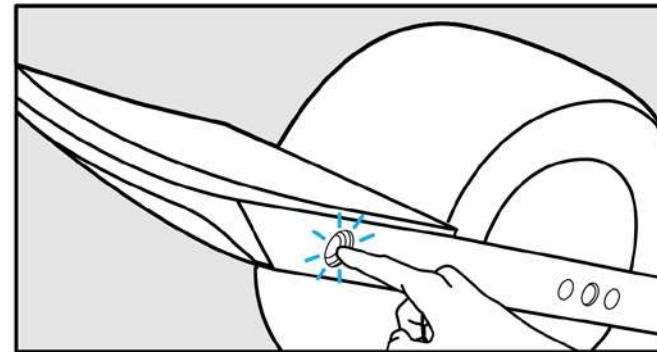

STATUS INDICATOR

LED STATUS RING INDICATOR

The LED ring on the pushbutton switch is the only status indicator for Onewheel+. The LED will indicate battery status and error codes for your Onewheel+.

NORMAL OPERATION

The LED Status Indicator will pulse slowly under normal operating conditions.

BATTERY STATUS

As the battery capacity diminishes during your ride, the LED Status Indicator will change its rate of pulsing so that the LED Status Ring indicator will remain off longer than it is on. This ratio of ON/OFF time indicates the current battery status. You can also check your battery status from the home screen of the Onewheel app.

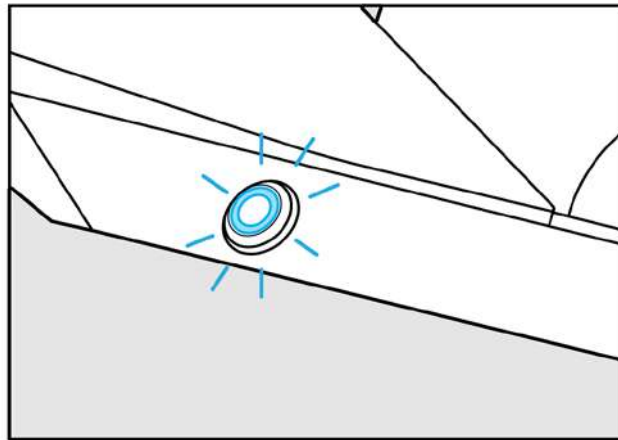

DECODING YOUR ONEWHEEL+

The different blink codes, differentiated by the number of blinks in a row, may indicate different issues with your Onewheel+.

Always count the blink code if one occurs. Sometimes you can solve the issue by charging the battery or by switching your Onewheel+ OFF and then ON again. If you are still experiencing problems, please contact Onewheel+ customer support at 1-800- 283-7943 or send an email to support@onewheel.com

# OF BLINKS	DESCRIPTION
01, 02	Low battery
03	Overcharged
04	Invalid power-up orientation
06	Motor stall detected
07	Out of range controller temperature
09	Bad accelerometer
10	Bad controller
11	Bad hall sensors
13, 14	Over-current detected
15	Footpad sensor pressed on power-up
16	Invalid hardware
17	Out of range battery temperature
18	Out of range motor temperature
21	Charger connected

GENERAL BOARD CARE

DAILY USE

To keep your board looking great and riding for years is pretty easy, just: **keep it dry, keep it clean, and keep it charged.** When you are done riding store your board in a warm, dry place. Don't leave it outside or in your car overnight.

WET ENVIRONMENTS

If you ride in any wet environments make sure you completely wipe your board off afterward, get all debris off and let it fully dry out before charging. The board is not waterproof, but water-resistant. Ride into wet environments at your own risk.

COLD WEATHER

Riding in the winter is a blast and Onewheels can be operated in the cold. Don't let the winter cold ruin your fun.

When you are done riding don't leave your Onewheel outside or in the trunk of your car. Long exposure to extremely cold temperature can adversely affect your board's health.

If you do happen to leave your Onewheel out in the cold you may have to bring your board in and warm it up [60°F/15°C] before it is ready to ride [You may see error 17 if battery temperature is too low]. It may take an hour or more to warm up to a rideable temperature.

BATTERY CARE

Leaving the board on the charger several days in a row will not damage the board although for long term storage, it is best to store as per the long term storage instructions.

- Leaving your board on the charger for several days in a row will not damage your board.
- Do not on leave your board on the charger for months.
- For long term storage make sure to charge between 40-50% and check it monthly.

LONG TERM STORAGE

Make sure to charge between 40-50% and store it in a dry place between 50°-60°F [10°-15°C]. Check monthly to ensure your battery remains between 40-50%.



**40-50%
CHARGE**



**50°-60°F
(10°-15°C)**



**CHECK
MONTHLY**

MORE WAYS TO RIDE SAFELY

05



NEVER MODIFY YOUR ONEWHEEL+

Fortunately, your Onewheel+ is pretty much perfect as is. So there's no need to add any extra bells and whistles. Modifying or changing the appearance or performance of your Onewheel+ is not advised and could potentially increase your risk of injury. If you have specific questions, please contact Onewheel+ customer support at 1-800-283-7943 or send an email to support@onewheel.com

- ⚠ WARNING:** Failure to confirm the compatibility of, or to properly install, operate or maintain any component or accessory on your Onewheel+ can result in serious injury or death and will void your warranty.
- ⚠ CAUTION:** Changing or modifying any Onewheel+ factory component will void your warranty.

MORE WAYS TO RIDE SAFELY

Observe all local traffic laws and regulations regarding riding on sidewalks and trails. It is your responsibility to know and obey the laws in your riding area.

Share the road and respect the rights and safety of other motorists, pedestrians and cyclists.

Ride defensively. Always assume that others do not see you.

⚠ WARNING: Never ride your Onewheel+ on inclines or declines with grades steeper than 15%. This may cause the motor and battery to overheat and will also void your warranty.

⚠ CAUTION: Jumping and stunt riding will void your warranty.

LOOK AHEAD, AND BE READY TO AVOID OR YIELD TO:

- Vehicles slowing or turning, entering your lane ahead of you or coming up behind you
- Parked cars or opening car doors
- Pedestrians
- Children or pets
- Pot holes, sewer grating, railroad tracks, expansion joints, road or sidewalk construction, debris and other obstructions that could cause you to swerve into traffic, catch your wheel or fall

ALWAYS WEAR:

- Shoes that stay on your feet and will grip the board. Never ride barefoot or while wearing sandals or flip-flops.
 - Bright clothing that makes you clearly visible to drivers, riders and pedestrians.
 - Protective eye wear to protect against the sun, as well as airborne dirt, dust and, of course, bugs.
- ⚠ WARNING:** Failure to wear a helmet when riding may result in serious injury or death.

- Always wear a ASTM F1492-08, CPSC and/ or CE EN1078 certified helmet, and follow the manufacturer's instructions for fit, use and care. Head injuries are some of the most serious and may be avoided with proper protection.
- Avoid sharp bumps, drainage grates and sudden surface changes.
- Avoid streets and surfaces with water, sand, gravel, dirt, leaves, and other debris. Wet weather impairs traction, braking and visibility.
- Never ride near motor vehicles.

MORE WAYS TO RIDE SAFELY

- Always ride in designated lanes or paths or as close to the edge of the road as possible in the direction of traffic flow or as directed by local laws.
- Never weave through traffic.
- Never carry a passenger.
- Stop at stop signs and traffic lights. Slow down and look both ways at street intersections. Be prepared to yield even if you have the right of way.
- Use approved hand signals for turning and stopping.
- Never carry anything that could obstruct your vision or that could cause you or your clothing to become entangled in the wheel.
- Never hitch a ride holding onto another moving vehicle or object.
- Never ride your Onewheel+ while under the influence of alcohol or drugs.
- Choose smooth stable paths made of concrete and asphalt.
- Observe and yield the right of way.

- Do not perform racing, stunt riding or other maneuvers that may cause loss of control.
- Do not allow body parts, clothes, etc. to come into contact with moving parts, wheels or drive train while the motor is running.
- Before each use, perform pre-operation checks as specified by the manufacturer.
- The owner shall allow use of the unit only after clearly demonstrating its proper and safe use and confirming that the operator understands all components and aspects of operation of the unit, and is wearing a helmet.

- Be thoroughly familiar with the way your Onewheel+ works (e.g., speed, direction, turning).
- Always keep body parts, clothing and other objects away from the wheel.
- Always do a mechanical safety check before getting on your Onewheel+.
- When riding, be aware of your environment. Ride at a speed appropriate for your conditions. Increased speed equals higher risk.

MORE WAYS TO RIDE SAFELY

- Do not ride at night or during times of low visibility [e.g., fog, rain, dusk, dawn].
- Follow all manufacturer's recommendations and instructions, as well as comply with all laws and ordinances.
- Components shall be maintained and repaired in accordance with manufacturer's specifications, only authorized replacement parts shall be used, and installation shall be by dealers or other skilled persons.
- Persons with heart conditions, pregnant women, persons with head/back/neck ailments, persons with mental or physical conditions that make them susceptible to injury, and persons with impaired capabilities should not operate.



ONEWHEEL+ SPECIFICATIONS

MOTOR	: 750W Hypercore® hub motor
BATTERY	: Lithium Iron Phosphate [LiFePo4] 48V
SENSORS	: Solid State MEMS 6-DOF
TIRE	: 11.5×6.5-6 Vega
MAX LEAN ANGLE	: >30 degrees
TOP SPEED	: 19MPH / 30KPH
TYPICAL RANGE	: 5-7 MI / 8-11 KM
DIMENSIONS	: 9×11.5×30 [IN] / 23×29.21×72.6 [CM]
WEIGHT	: 25 LB / 11 KG
RECHARGE TIME	: 30 mins* [FY5803500 charger]

*CHARGE TIME ESTIMATED STARTING FROM A 10%-90% CHARGE.

ULTRACHARGER SPECIFICATIONS

INPUT	: AC100-240V 50/60Hz 300VA
OUTPUT	: +58VDC  3.5A
MODEL #	: FY5803500

OPERATING TEMPERATURE RANGE : 0C to 50C

OPERATING HUMIDITY RANGE : 0 to 100% RH
[non-condensing]

ONEWHEEL+ XR SPECIFICATIONS

MOTOR	: 750W Hypercore® hub motor
BATTERY	: Nickel Manganese Cobalt Oxide [NMC]
SENSORS	: Solid State MEMS 6-DOF
TIRE	: 11.5×6.5-6 Vega
MAX LEAN ANGLE	: >30 degrees
TOP SPEED	: 19MPH / 30KPH
TYPICAL RANGE	: 12-18 MI / 19-29 KM
DIMENSIONS	: 9×11.5×30 [IN] / 23×29.21×72.6 [CM]
WEIGHT	: 27 LB / 12.5 KG
RECHARGE TIME	: 100 mins* [FY6303200 charger]

*CHARGE TIME ESTIMATED STARTING FROM A 10%-90% CHARGE.

XR CHARGER SPECIFICATIONS

INPUT	: AC100-240V 50/60Hz 300VA
OUTPUT	: +63VDC  3.2A
MODEL #	: FY6303200

OPERATING TEMPERATURE RANGE : 0C to 50C

OPERATING HUMIDITY RANGE : 0 to 100% RH
[non-condensing]

WARRANTY

WARRANTY This agreement outlines the **LIMITED WARRANTY** coverage supplied by Future Motion Inc., hereinafter to be called the **COMPANY**, to the **USER**, which is defined as an individual who has purchased the Onewheel Pint (hereinafter to be called the **PRODUCT**) in a retail establishment or via an on-line storefront as approved by the **COMPANY** or from a **COMPANY**-authorized sales representative. Purchasing any **PRODUCT** from an unauthorized reseller, including any online purchase other than directly from the **COMPANY**, will void all product warranties to the extent permitted by law.

The **COMPANY** warrants that the **PRODUCT**, other than the footpad, tire and battery pack, will be free from defects in materials and workmanship for a period of 12 months/2000 KM [1243 miles], whichever comes first. The warranty for the footpad, tire and battery pack is 6 months/1000 KM [622 miles].

If the **PRODUCT** proves defective **AND** a claim is filed during the warranty period, the **COMPANY**, at its option, will:

- 01** Repair the **PRODUCT** by means of telephone support, email support, or by providing service at no charge for parts or labor,
- 02** Replace the **PRODUCT** with a comparable **PRODUCT** which may be new or refurbished.
- 03** Refund the original amount paid for the **PRODUCT**, less a reasonable allowance for usage, upon its return.

The **COMPANY** recommends that the **USER** first utilize support materials shipped with the **PRODUCT**, **PRODUCT** diagnostics, information contained on the Internet, and email support. If unsuccessful, to obtain service under this **WARRANTY** the **USER** must notify the **COMPANY** or its authorized service.

Future Motion provides paid repairs for products that are out of warranty.

All Sales are Final.

~~X~~ If you wish to discard this product please contact your local authorities or dealer and ask for the correct method of disposal.

COMPONENT WARRANTY DURATION NOTES [For defects in materials and workmanship.]

COMPONENTS	WARRANTY DURATION	NOTES
Onewheel+	1 year	Parts that are not listed separately
Footpad, Tire, Battery Pack	6 months	

WARRANTY

THE FOLLOWING ARE NOT COVERED BY THE WARRANTY

- Total mileage is over 2000km/1243miles .
- Damage has been caused by modification or use outside those specified in the User Manual.
- The barcode or serial number of the product has been altered or removed.
- The warranty registration is inconsistent with the product itself.
- The product has been dismantled or repaired by an unauthorized third party .
- Water damage is not covered under warranty.
- Damage or fault has been caused by other issues [excluding product design, manufacture, quality, etc.].

- Natural wear and tear that does not affect product function (including scratches and wear and tear on frame rails, footpad, tires, etc).
- Damage has been caused by accidents or human errors, such as breakage caused by dropping or rusting in a very wet environment.
- Damage has been caused by overloading the Onewheel.
- Damage has been caused by acts-of-god such as fire, flood, earthquake, freezing, etc.
- Products purchased from an unauthorized reseller, including any online purchase other than directly from Future Motion, Inc., to the extent permitted by law.

ALL IMPLIED WARRANTIES (INCLUDING BUT NOT LIMITED TO THE IMPLIED WARRANTIES OF MERCHANTABILITY AND FITNESS FOR A PARTICULAR PURPOSE) ARE LIMITED IN DURATION TO THE ABOVE 12 MONTH/6 MONTH WARRANTY PERIOD. FUTURE MOTION INC. FURTHER DISCLAIMS ALL EXPRESS WARRANTIES.

Some states do not allow limitations on how long an implied warranty lasts, so the above limitation may not apply to you if inconsistent with controlling state law.





DECLARATION OF CONFORMITY

ONEWHEEL+ XR: SELF-BALANCING ELECTRIC SKATEBOARD

PRODUCT: Onewheel+ XR: Self-Balancing Electric Skateboard

TYPE MODEL: OW1-00006-00

MANUFACTURER: Future Motion Inc

MANUFACTURER ADDRESS:

1201 Shaffer Rd.

Santa Cruz, CA 95060, USA

EU Machinery Directive 2006_42_EG

Council Directive 2014/30/EU on Electromagnetic

Compatibility:

EN 55022 Class B Limits

EN 55024

EN 60204

EN ISO 12100

The undersigned hereby declares, on behalf of Future Motion Inc. of Santa Cruz, CA, that the above-referenced product, to which this declaration relates, is in conformity with the provisions of:

The Technical Construction File is maintained at the corporate headquarters at 1201 Shaffer Rd, Santa Cruz, CA 95060, USA.

Signed 
Kyle Doerksen. Founder, CEO

CE

15.02.2020

SAY HI

1201 Shaffer Rd.
Santa Cruz, CA 95060, USA
1-800-283-7943

Copyright © 2020 Future Motion Inc
Onewheel+ ® is a trademark of Future Motion Inc.

Onewheel+ is protected by numerous patents in the U.S. and world-wide.
See www.onewheel.com/patents for more information.

All Sales are Final





ONEWHEEL+ XR OWNER'S MANUAL V2.9 [Original Instructions]

Manuals in other languages are available at
www.onewheel.com/support